

MAPS™ 5G N12 Interface Emulator

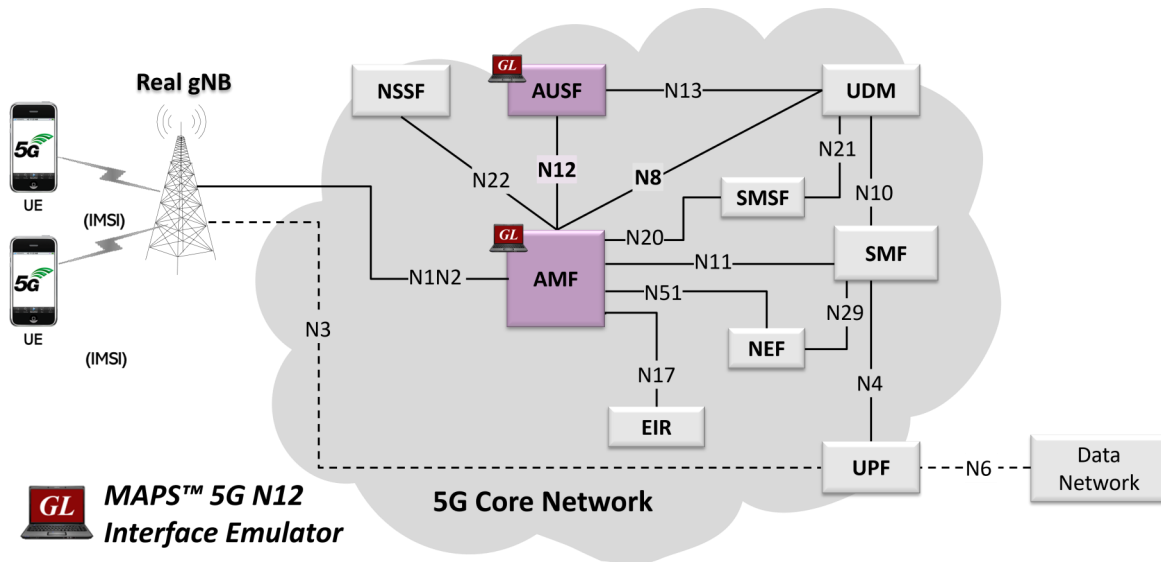

Overview

5G system as a service-based architecture, includes a set of Network Functions (NFs) providing services as defined in 3GPP TS 23.501. The service-based interfaces use HTTP/HTTP2 protocol with JavaScript Object Notation (JSON) as the application layer serialization protocol.

GL's MAPS™ emulate AUSF (Authentication Server Function) within the 5G Core offering services to the AMF (Access and Mobility Management Function) via the Nausf service based N12 interface. The above figure represents the service-based interface, with the focus on the AUSF and AMF. Here, AUSF acts as producer, and it refers to the Specification TS29.509.

The NFs and AUSF are the entities in the 5G Core Network (5GC), which supports the following services via the Nausf service-based N12 interface:

- Nausf_UEAuthentication (Authentication and Key Agreement)
- Authentication Result Removal with 5G AKA method

Besides emulating network elements in AUSF and AMF function, it also supports error tracking, regression testing, load testing / call generation. It can run pre-defined test scenarios against 5G interface test objects in a controlled and deterministic manner. Easy to use script syntax allows user to create conformance test cases based on their test plan.

MAPS™ 5G N12 interface emulator supports utilities such as Script Editor and Profile Editor which allow new scenarios to be created or modified using 5G N12 JSON messages and parameters.

For more information on MAPS™ 5G N12 refer to [MAPS™ 5G N12 Interface Emulator](#) webpage.

Main Features

- Emulate AUSF and AMF elements
- Supports AKA (Authentication and Key Agreement) service via the Nausf service-based N12 interface
- Services use REST APIs based on HTTP and JSON data format
- Supports TLS and TCP transports
- Supports scripted call generation and automated call reception
- Supports customization of call flow and message templates using Script Editor
- Ready-to-use scripts for quick testing
- Provides Call Statistics and Events Status
- Emulate Multiple Subscribers using CSV profiles
- Run tests 24/7 for Automation, Remote access, and Schedulers



818 West Diamond Avenue - Third Floor, Gaithersburg, MD 20878, U.S.A
(Web) www.gl.com - (V) +1-301-670-4784 (F) +1-301-670-9187 - (E-Mail) info@gl.com

Testbed Configuration

The testbed setup window allows users to setup the required test configurations in N12 interface. It includes a list of variables that are declared and assigned before starting the script. Testbed Setup defines the MAPS™ parameters which communicates with the rest of the test network. End user configuration profile is used to configure MAPS™ 5G N12 interface with the supported AMF and AUSF parameters.

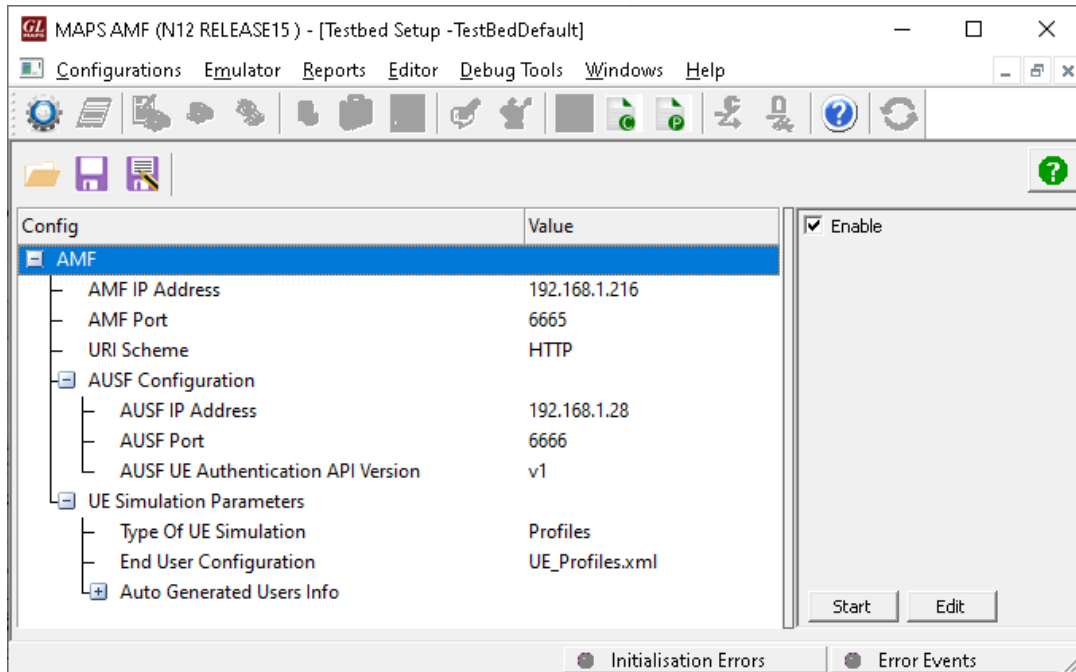

Figure: Testbed Setup

Pre-processing Tools

SCRIPT EDITOR - The script editor allows user to create/edit scripts and access protocol fields as variables for the message template parameters. The script uses pre-defined message templates, to perform send and receive actions.

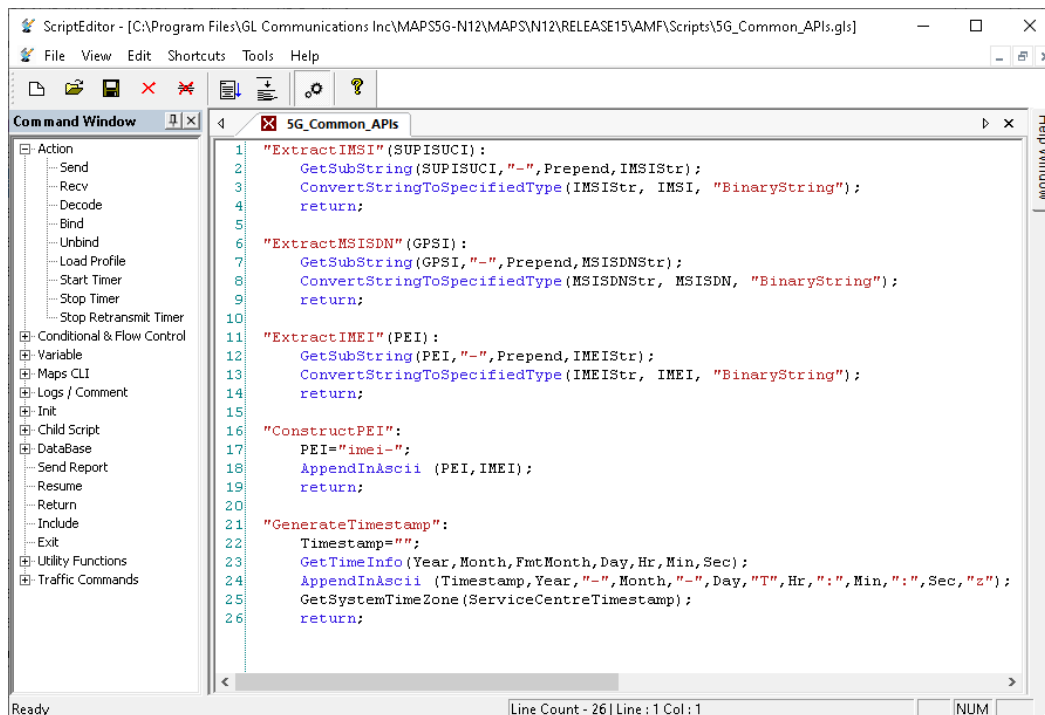

Figure: Script Editor

Pre-processing Tools (Contd.)

PROFILE EDITOR - This feature allows loading profile to edit the values of variables using GUI, replacing the original value of variables in the message template. An XML file defines a set of multiple profiles with varying parameter values which allows users to configure call instances in call generation to receive calls. The UE_Profiles includes 5G parameters, that is required to configure multiple UEs to emulate Signaling and Traffic.

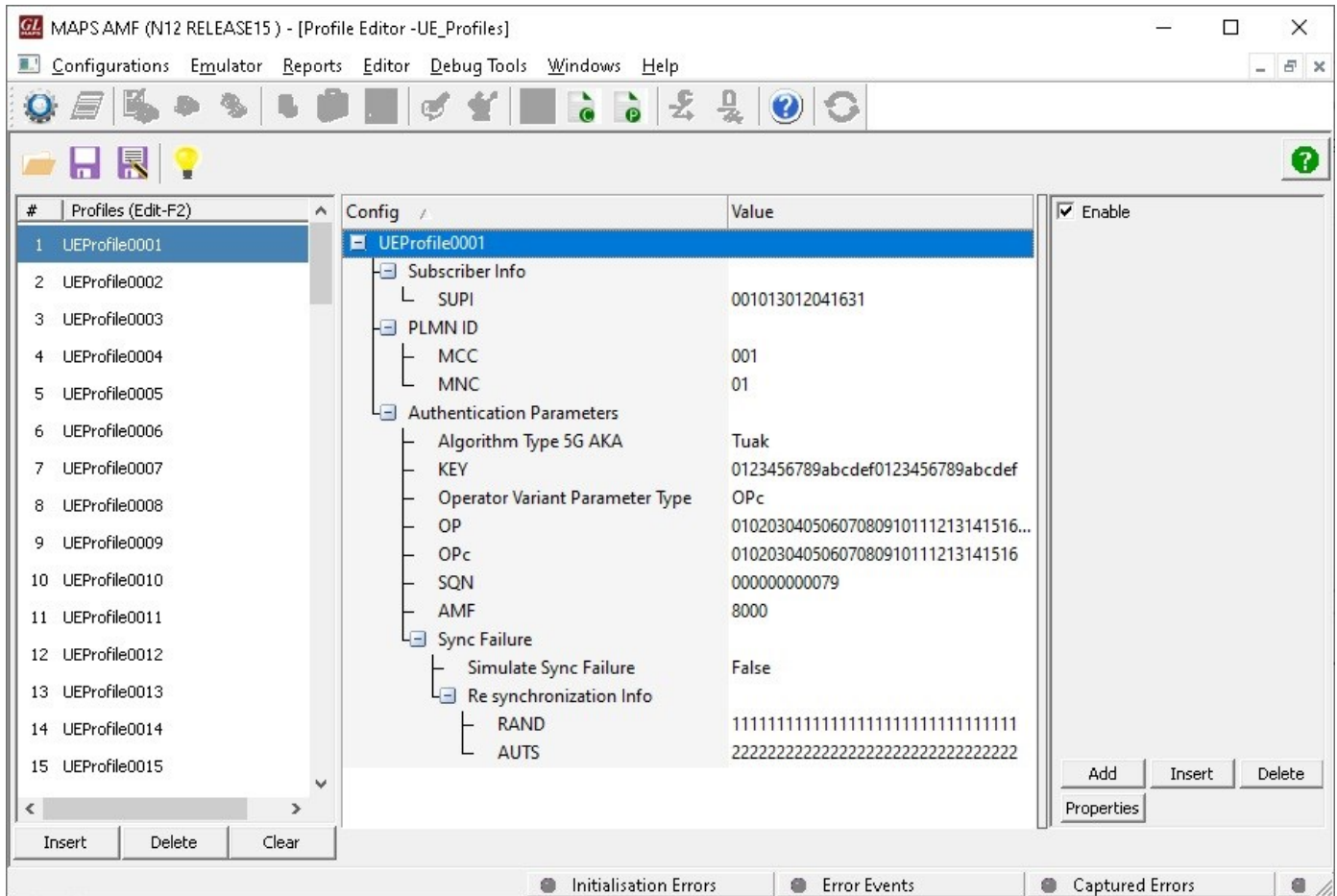

Figure: Profile Editor

Call Generation and Reception

In call generation mode, MAPS™ is configured for the outgoing messages, while in call receive mode, it is configured to respond to the incoming messages. Tests can be configured to run once, multiple iterations and continuously. Also, allows users to create multiple entries using quick configuration feature

The editor allows to run the added scripts sequentially (order in which the scripts are added in the window) or randomly (any script from the list of added script as per the call flow requirements).

The test scripts are started manually at call generation, and at the call reception, the script is automatically triggered by incoming messages.

The screenshot shows the MAPS AMF (N12 RELEASE15) - [Call Generation - CallGenDefault] interface. It features a menu bar with options like Configurations, Emulator, Reports, Editor, Debug Tools, Windows, and Help. Below the menu is a toolbar with various icons. The main area contains a table with the following data:

Sr No	Script Name	Profile	Call Info	Script Execution	Status	Events	Result	Total Iteratio
1	Nausf_AMF_UEAuthentication_Request.gls	UEProfile0001	suci-0-001-01-0-0-0-3012041631	Start	Authentication Successful	None	Pass	1
2	Nausf_AMF_UEAuthentication_Request.gls			Start		None	Unknown	1
3	Nausf_AMF_UEAuthentication_Request.gls			Start		None	Unknown	1
4	Nausf_AMF_UEAuthentication_Request.gls			Start		None	Unknown	1

Below the table is a control bar with buttons: Add, Delete, Insert, Refresh, Start, Start All, Stop, Stop All, Abort, Abort All. Underneath are options for Save, Column Width, and Show Latest. The main display area shows a message sequence diagram between AMF and AUSF. The diagram includes a POST request from AMF to AUSF at 09:15:03.80900, a 201 CREATED response from AUSF to AMF at 09:15:03.82500, a PUT request from AMF to AUSF at 09:15:03.82900, and a 200 OK response from AUSF to AMF at 09:15:03.85300. To the right of the diagram is a JSON response snippet:

```

POST http://192.168.1.28:6666/nausf-auth/v1/ue-auth
content-type : application/json
accept : application/3gppHal+json,
application/problem+json
{
  "servingNetworkName": "5G:mnc001.mcc001.3gppnetwork.
  "supiOrSuci": "suci-0-001-01-0-0-0-3012041631"
}
    
```

At the bottom, there are tabs for Scripts, Message Sequence, Event Config, and Script Flow. The status bar at the very bottom shows options for Initialisation Errors, Error Events, Captured Errors, and Link Statu.

Figure: Call Generation

The screenshot shows the MAPS AUSF (N12 RELEASE15) - [Call Reception] interface. It features a menu bar with options like Configurations, Emulator, Reports, Editor, Debug Tools, Windows, and Help. Below the menu is a toolbar with various icons. The main area contains a table with the following data:

Sr No	Script Name	Profile	Call Info	Script Execution	Status	Events	Results
1	Nausf_Control.gls		suci-0-001-01-0-0-0-3012041631	Completed	Authentication Vectors sent	None	Pass
2	Nausf_Control.gls		AuthCtx_001013012041631	Completed	Authentication Successful	None	Pass
3	Nausf_Control.gls		suci-0-001-01-0-0-0-3012041631	Completed	Authentication Vectors sent	None	Pass
4	Nausf_Control.gls		AuthCtx_001013012041631	Completed	Authentication Successful	None	Pass

Below the table is a control bar with buttons: Stop, Stop All, Abort, Abort All, Show Records, Select Active Call, Auto Trash, Trash. Underneath are options for Save, Column Width, and Show Latest. The main display area shows a message sequence diagram between AMF and AUSF. The diagram includes a PUT request from AMF to AUSF at 09:14:42.533000 and a 200 response from AUSF to AMF at 09:14:42.535000. To the right of the diagram is a JSON response snippet:

```

Status: 3
:method : PUT
:path : /nausf-auth/v1/ue-authentications/AuthCtx_001013012
:scheme : http
:authority : 192.168.1.28:6666
content-type : application/json
accept : application/json,
application/problem+json
content-length : 46
{
  "resStar": "434C3C54DE4CB4BCDBE121BC9F7916A5"
}
    
```

At the bottom, there are tabs for Scripts, Message Sequence, Event Config, and Script Flow. The status bar at the very bottom shows options for Initialisation Errors, Error Events, Captured Errors, and Link S.

Figure: Call Reception

UE Authentication Service

MAPS™ for N12 interface emulate services between AMF and AUSF network functions. MAPS™ supports 5G-AKA (Authentication and Key Agreement) service.

In this procedure, the AMF requests the authentication of the UE by providing UE related information and the serving network name and the 5G AKA is selected. The AMF returns the result received from the UE to the AUSF.

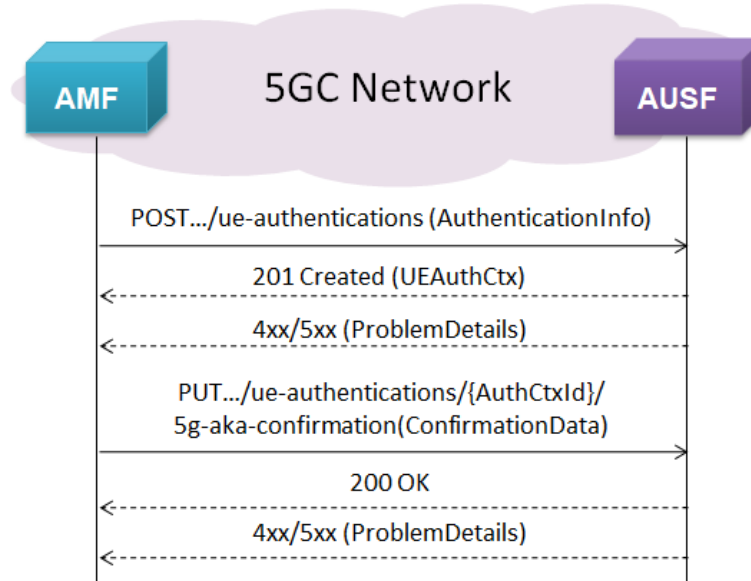

- AMF sends a POST request to the AUSF containing UE Id and the Serving Network Name.
- On success, "201 Created" is returned.
- Based on the relation type, AMF sends a PUT containing the "RES*" provided by the UE.
- On success, "200 OK" is returned, indicating successful RES* verification in the AUSF.

Authentication Result Removal with 5G AKA method

MAPS™ for N12 interface emulate services between AMF and AUSF network functions. MAPS™ supports Authentication Result Removal with 5G AKA method service.

In this procedure, the AMF requests AUSF to inform the UDM to remove the authentication result.

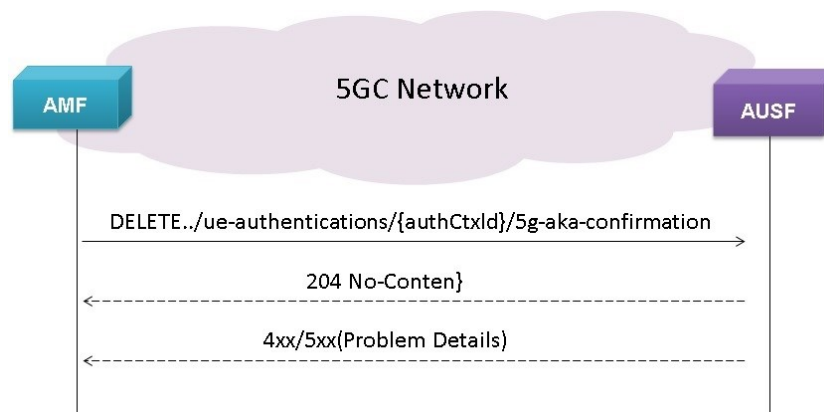

- The NF Service Consumer (AMF) shall send a DELETE request to the resource URI representing the sub-resource "5G AKA confirmation". The request body shall be empty.
- On success, "204 No Content" shall be returned.
- On failure, one of the HTTP status code shall be returned with the message body containing a ProblemDetails

Supported Protocols and Specifications

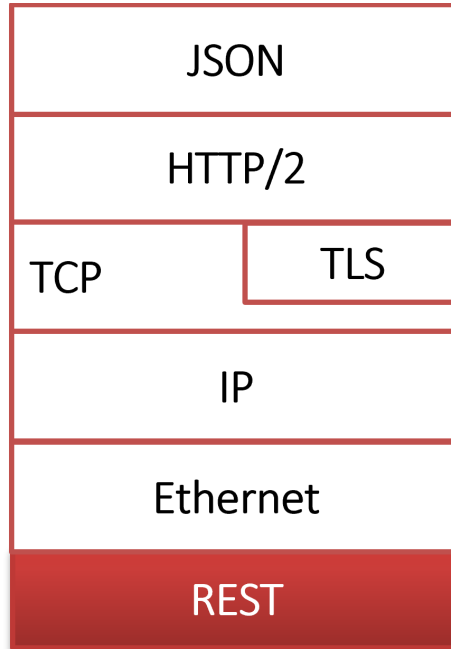

Supported Protocols	Standard/ Specification
N12 Interface (AUSF - AMF)	TS29.509 Release 17, version 0.0.0
JavaScript Object Notation (JSON)	IETF RFC 8259
HTTP2	IETF RFC 7231 IETF RFC 7540/RFC 7541
TLS	IETF RFC 8446
TCP	IETF RFC 793
IPv4	IETF RFC 791 [5] IETF RFC 2460 [6]

Buyer's Guide

Item No	Product Description
PKS506	MAPS™ 5G N12 Interface Emulator
PKS305	MAPS™ 5G Multi-Interface Emulation

Item No	Related Software
PKS500	MAPS™ 5G N1/N2 Interface Emulator
PKS501	MAPS™ 5G N4 Interface Emulator
PKS502	5G Service based Emulation (Prerequisite base license for all service based (Open API) interface emulations)
PKS503	MAPS™ 5G N8 Interface Emulation (Requires PKS502)
PKS504	MAPS™ 5G N10 Interface Emulation (Requires PKS502)
PKS505	MAPS™ 5G N11 Interface Emulation (Requires PKS502)
PKS507	MAPS™ 5G N13 Interface Emulation (Requires PKS502)
PKS502	MAPS™ 5G N17 Interface Emulator
PKS508	MAPS™ 5G N20 Interface Emulator (Requires PKS502)
PKS509	MAPS™ 5G N21 Interface Emulator (Requires PKS502)
PKS510	MAPS™ 5G N22 Interface Emulator (Requires PKS502)
PKS511	MAPS™ 5G N29 Interface Emulator (Requires PKS502)
PKS511	MAPS™ 5G N51 Interface Emulator (Requires PKS502)

For complete list of MAPS™ products, refer to [Message Automation & Protocol Simulation \(MAPS™\)](#) webpage.

For more details on supported MAPS™ 5G interfaces, refer to [5G Core \(5GC\) Network Test Solution](#) webpage.