

MAPS™ 5G N51 Interface Emulator

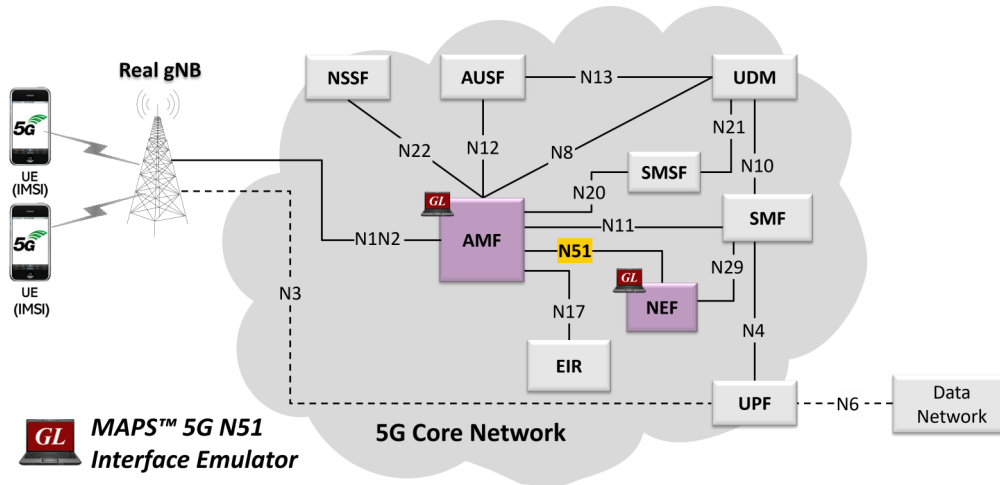

Overview

GL's MAPS™ 5G System as a service-based architecture, includes a set of Network Functions (NFs) providing services as defined in 3GPP TS 29.508. The service-based interfaces use HTTP protocol with JavaScript Object Notation (JSON) as the application layer serialization protocol.

GL's MAPS™ 5G N51 emulate Network Exposure Function (NEF) within the 5G Core offering services to the Access and Mobility Management Function (AMF) via the Namf service-based N51 interface. The above network architecture represents the service-based architecture, with focus on N51 between NEF and AMF. Here, node NEF can act as "NF Producer", which refers to TS29.508 Specification.

The NEF and AMF are the entities in 5G Core Network (5GC), which supports the following services

- UE Subscription for notification for one time event detection
 - Registration State Change Event
 - Connection State Change Event
 - Location Report Event
 - Presence In Area of Interest Event

Besides emulating network elements NEF and AMF functions, it also supports error tracking, regression testing, load testing. It can run pre-defined test scenarios against 5G interface test objects in a controlled and deterministic manner. Easy to use script syntax allow user to create conformance test cases based on their test plan.

MAPS™ 5G N51 Interface emulator supports powerful utilities such as Script Editor and Profile Editor which allow new scenarios to be created or existing scenarios to be modified using 5G N51's JSON messages and parameters

For more information, visit [MAPS™ 5G N51 Interface Emulator](#) webpage.

Main Features

- Emulate NEF and AMF elements
- Supports UE Subscription for notification of one time event detection (Registration State Change Event, Connection State Change Event, Location Report Event, and Presence In Area of Interest Event)
- Services use REST APIs based on HTTP and JSON data format
- Supports TLS and TCP transports
- Supports scripted call generation and automated call reception
- Supports customization of call flow and message templates using Script and Message Editor
- Ready-to-use scripts for quick testing
- Provides Call Statistics and Events Status
- Automation, Remote access, and Schedulers to run tests 24/7



818 West Diamond Avenue - Third Floor, Gaithersburg, MD 20878, U.S.A
(Web) www.gl.com - (V) +1-301-670-4784 (F) +1-301-670-9187 - (E-Mail) info@gl.com

Testbed Configuration

The testbed setup window allow user to setup the required test configurations in N51 interface. It includes a list of variables that are declared and assigned before starting the script. Testbed Setup defines the MAPS™ parameters which communicates with the rest of the test network. End user configuration profile is used to configure MAPS™ 5G 51 interface with the supported NEF and AMF parameters.

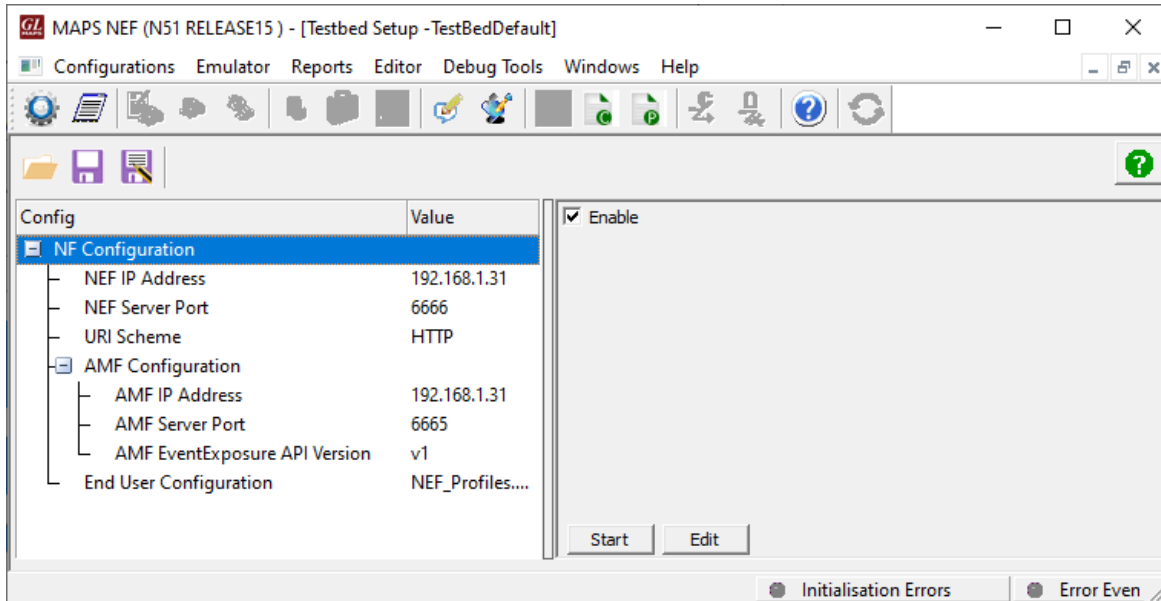

Figure: Testbed Setup

Pre-processing Tools

PROFILE EDITOR - This feature allow loading profile to edit the values of variables using GUI, replacing the original value of variables in the message template. An XML file defines a set of multiple profiles with varying parameter values which allow user to configure call instances in call generation to receive calls. The **UE_Profiles** include 5G UE parameters, that is required to configure multiple UEs to emulate signaling.

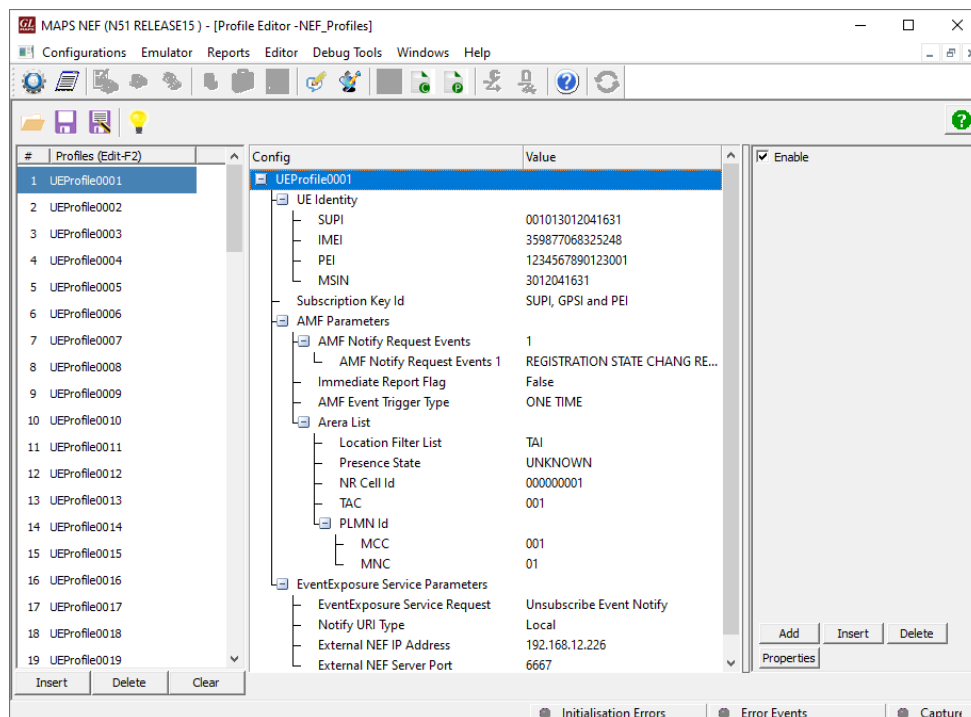

Figure: Profile Editor

Pre-processing Tools (Contd.)

SCRIPT EDITOR - The script editor allow user to create/edit scripts and access protocol fields as variables for the message template parameters. The script uses pre-defined message templates, to perform send and receive actions.

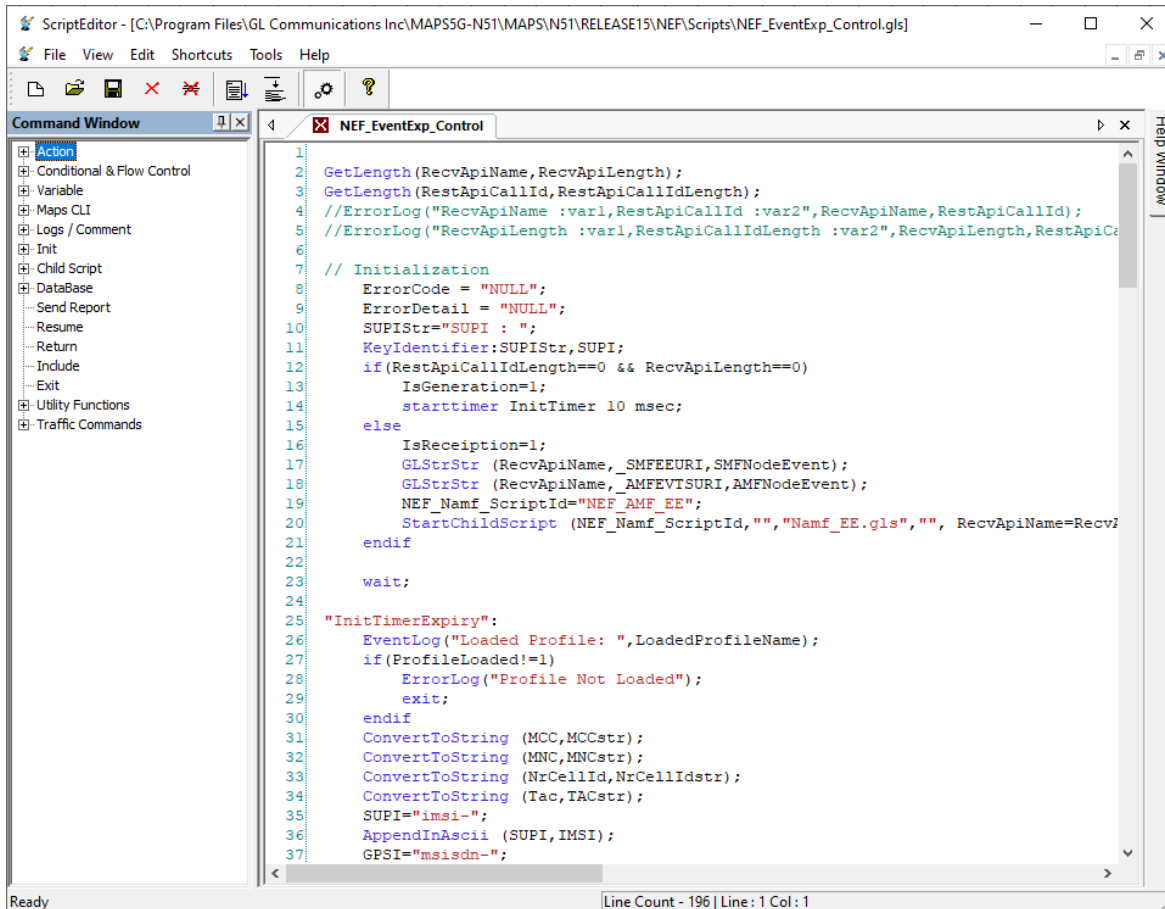

Figure: Script Editor

Call Generation and Reception

In call generation mode, MAPS™ is configured for the outgoing messages, while in call receive mode, it is configured to respond to the incoming messages. Tests can be configured to run once, multiple iterations and continuously. Also, allow user to create multiple entries using quick configuration feature. The editor allow to run the added scripts sequentially (order in which the scripts are added in the window) or randomly (any script from the list of added script as per the call flow requirements). The test scripts are started manually at call generation, and at the call reception the script is automatically triggered by incoming messages.

Sr...	Script Name	Profile	Call Info	Script Execution	Status	Events	Events Profile	Result	Total Iterations	Completed Iterations
1	Client_Connection.gls			Start		None		Unknown	1	0
2	NEF_EventExp_Control.gls	UEProfile0001	SUPI :imsi-001013012041631	Start	Namf EE SessionEstEventNotify Response Sent	None		Pass	1	1
3	NEF_EventExp_Control.gls			Start		None		Unknown	1	0
4	NEF_EventExp_Control.gls			Start		None		Unknown	1	0
5	NEF_EventExp_Control.gls			Start		None		Unknown	1	0
6	NEF_EventExp_Control.gls			Start		None		Unknown	1	0
7	NEF_EventExp_Control.gls			Start		None		Unknown	1	0
8	NEF_EventExp_Control.gls			Start		None		Unknown	1	0

Figure: Call Generation

Sr No	Script Name	Profile	Call Info	Script Execut...	Status	Events	Events Profile	Results
1	Namf_EventExp_C...		imsi-001013012041631	Completed	One Time Notification sent	None		Pass
2	Namf_EventExp_C...		SUPI :imsi-0010130120416...	Completed	Namf EE Notify Response Received	None		Pass

Figure: Call Reception

UE Subscription Notification for One Time Event Detection

Creation of Subscription

MAPS™ for 5G N51 interface emulate services between NEF and AMF network functions. The subscribe service operation is used to create subscription to an event for one UE or group of UE's. The below figure shows the NEF (as Service Consumer) sends the subscription request through HTTP post to AMF to create new event on subscription AMF.

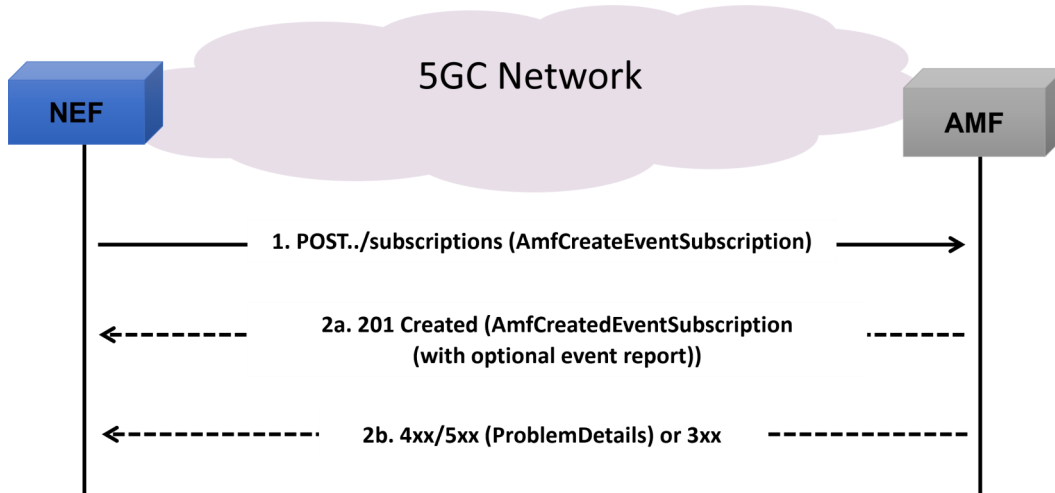

Figure: Subscribe for Creation

In this procedure, NEF sends HTTP POST request to create an event for new subscription to the AMF. On success, AMF includes a HTTP Location header to provide the location of a newly created subscription together with the status code 201 indicating the requested resource is created. On failure, HTTP status code 4xx/5xx response is returned indicating the creation of subscription has failed due to application error like UE_NOT_SERVED_BY_AMF.

Unsubscribe

The unsubscribe operation deletes the existing subscription information that is created by AMF. The figure below shows that the NEF (NF Service consumer) sends unsubscribe (delete) request to the AMF.

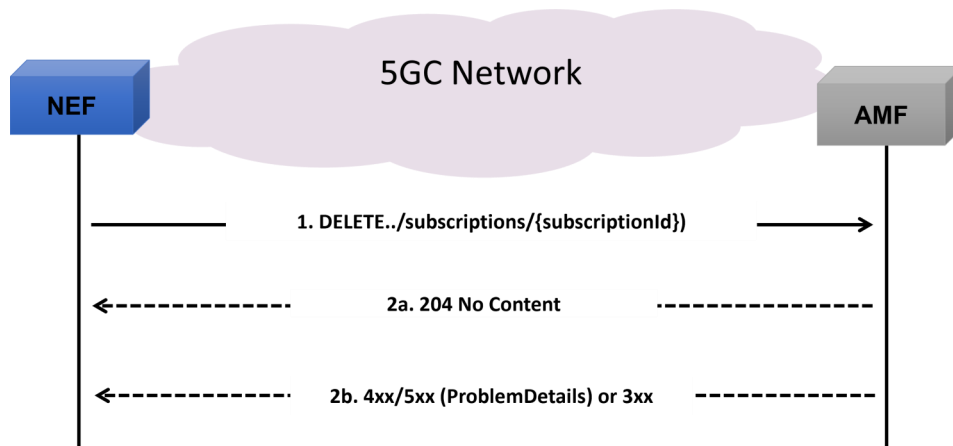

Figure: Unsubscribe a Subscription

In this procedure, NEF sends a HTTP DELETE request to the AMF requesting to delete the existing subscription information. On success, "204 No Content" returned indicating the subscription ID is successfully deleted. On failure, HTTP status code 4xx/5xx response is returned due to application error.

UE Subscription Notification for One Time Event Detection (Contd.)

Notify Subscription

The Notify service is used by NEF from AMF to notify any event(s) for one UE, group of UE(s) or any UE when certain event included in the subscription has taken place .

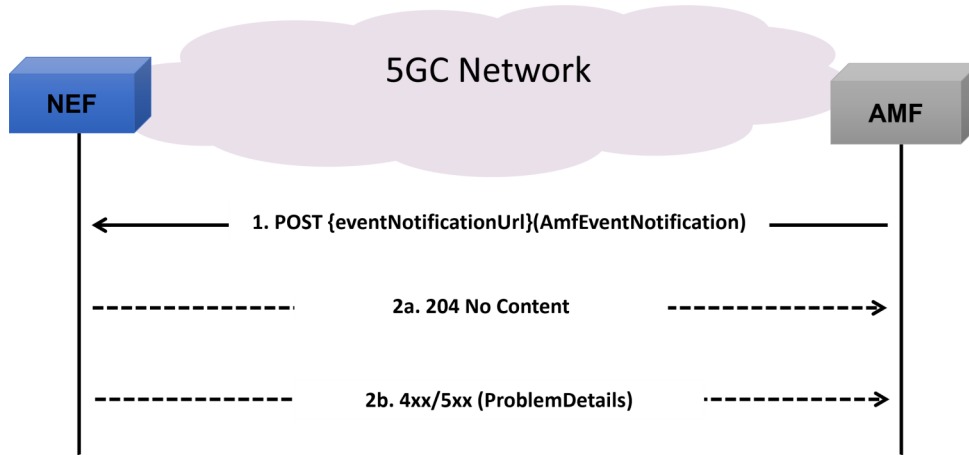

Figure: Notify to Subscription

In this procedure, the AMF sends a HTTP POST request to the NEF towards the notification on occurrence of event within the subscription. On success, the "204 No Content" is returned. On failure, HTTP status code 4xx/5xx response is returned due to application error.

The Notify service operation includes the following events.

- Registration State Change Event - for onetime / on every event detection
- Connection State Change Event - for onetime / on every event detection
- Location Report Event - for onetime / on every event detection
- Presence In Area of Interest Event - for onetime / on every event detection

Registration State Change Event

The NEF sends a HTTP POST request to AMF to notify about the current registration state of a UE or a group of UEs or any UE.

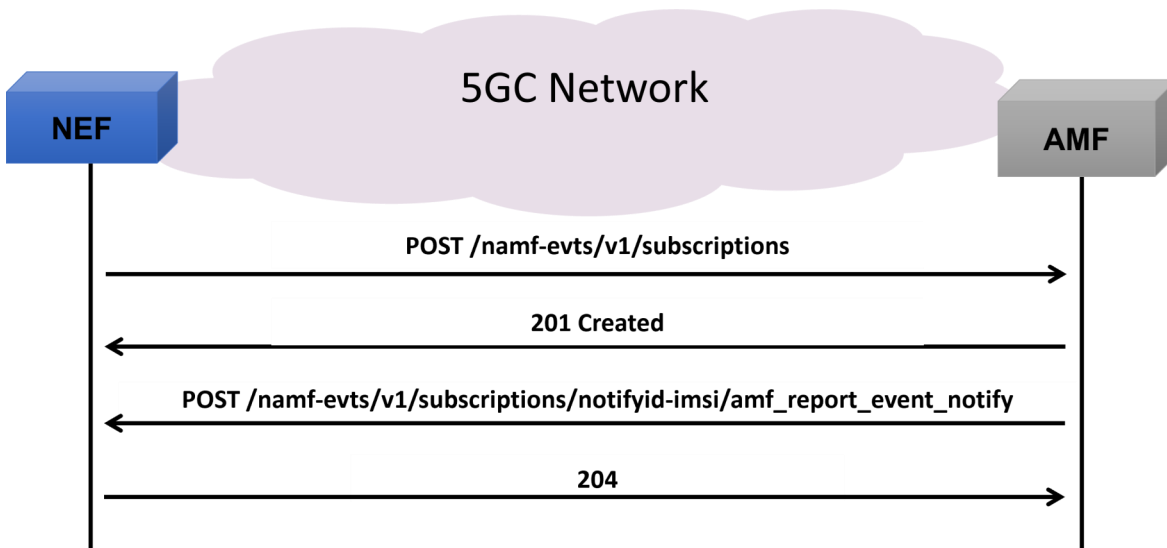
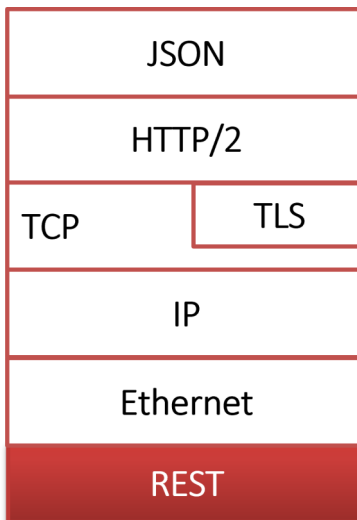

Figure: Registration State Change Event

Supported Protocols and Specifications



Supported Protocols	Standard / Specification
N51 Interface (NEF-AMF)	TS29.508
JavaScript Object Notation (JSON)	IETF RFC 8259
HTTP/2	IETF RFC 7540
TCP/TLS	IETF RFC 793
IPv4	IETF RFC 791 [5] IETF RFC 2460 [6]

Buyer's Guide

Item No	Product Description
PKS511	MAPS™ 5G N51 Interface Emulator (Requires PKS502)
PKS305	MAPS™ 5G Multi-Interface Emulation

Item No	Related Software
PKS500	MAPS™ 5G N1/N2 Interface Emulator
PKS501	MAPS™ 5G N4 Interface Emulator
PKS502	5G service-based Emulation (Prerequisite base license for all service-based (Open API) interface emulations)
PKS503	MAPS™ 5G N8 Interface Emulator (Requires PKS502)
PKS504	MAPS™ 5G N10 Interface Emulator (Requires PKS502)
PKS505	MAPS™ 5G N11 Interface Emulator (Requires PKS502)
PKS506	MAPS™ 5G N12 Interface Emulator (Requires PKS502)
PKS507	MAPS™ 5G N13 Interface Emulation (Requires PKS502)
PKS502	MAPS™ 5G N17 Interface Emulator
PKS508	MAPS™ 5G N20 Interface Emulator (Requires PKS502)
PKS509	MAPS™ 5G N21 Interface Emulator (Requires PKS502)
PKS510	MAPS™ 5G N22 Interface Emulator (Requires PKS502)
PKS511	MAPS™ 5G N29 Interface Emulator (Requires PKS502)

For complete list of MAPS™ products, refer to [Message Automation & Protocol Simulation \(MAPS™\)](#) webpage.

For more details on supported MAPS™ 5G interfaces, refer to [5G Core \(5GC\) Network Test Solution](#) webpage.