

MAPS™ 5G N13 Interface Emulator Brochure

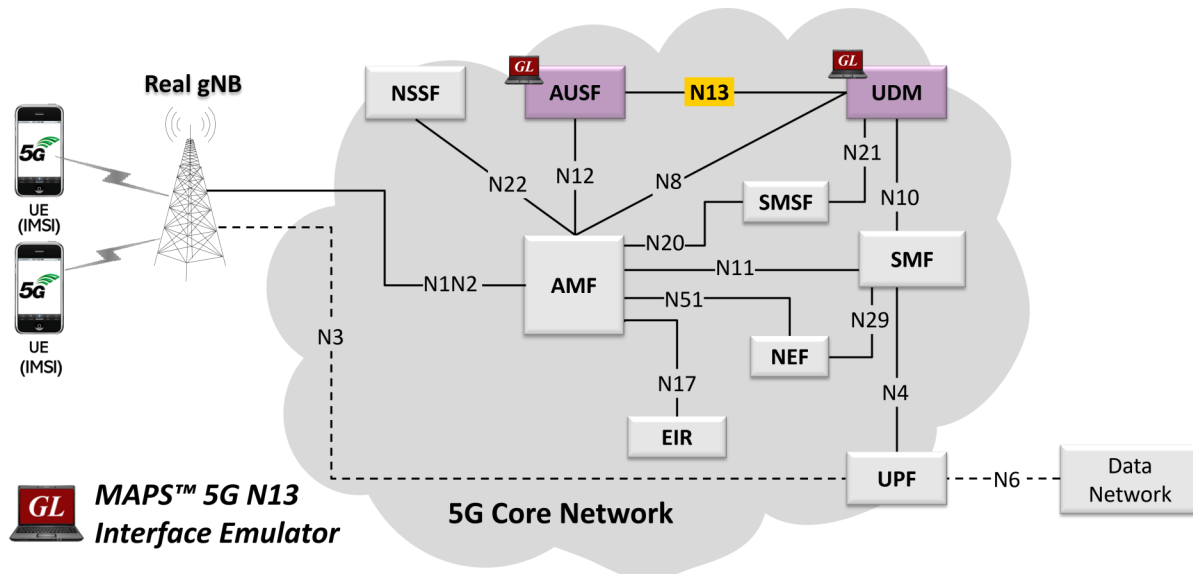

Overview

GL's MAPS™ 5G System as a service-based architecture, includes a set of Network Functions (NFs) providing services as defined in 3GPP TS 23.501. The service-based interfaces use HTTP/2 protocol with JavaScript Object Notation (JSON) as the application layer serialization protocol.

GL's MAPS™ Authentication Server Function (AUSF) within the 5G Core offering services to the User Data Management (UDM) via the Nausf and Nudm service-based N13 interface respectively. The above network architecture represents the service-based architecture, with focus on N13 between AUSF and UDM. Here, UDM acts as producer, where UDM producer refers to the Specification TS29.509.

The NF, AUSF and UDM are the entities in 5G Core Network (5GC), which supports the following services via Nudm service-based N13 interface:

- Nudm_UEAuthentication Services: Get and ResultConfirmation operations.

Besides emulating network elements AUSF and UDM functions, it also supports error tracking, regression testing, load testing. It can run pre-defined test scenarios against 5G interface test objects in a controlled and deterministic manner. Easy to use script syntax allows user to create conformance test cases based on their test plan.

MAPS™ 5G N13 Interface Emulator supports powerful utilities such as Script Editor and Profile Editor which allows new scenarios to be created or existing scenarios to be modified using 5G N13 JSON messages and parameters.

For more details, refer to [MAPS™ 5G N13 Interface Emulator](#) webpage.

Main Features

- Emulate AUSF and UDM elements
- Supports Nudm_UEAuthentication Services Procedure
- Services use REST APIs based on HTTP and JSON data format
- Supports TLS and TCP transports
- Supports scripted call generation and automated call reception
- Supports customization of call flow and message templates using Script
- Ready-to-use scripts for quick testing
- Provides Call Statistics and Events Status
- Generate multiple subscribers using the CSV profiles
- Automation, Remote access, and Schedulers to run tests 24/7



818 West Diamond Avenue - Third Floor, Gaithersburg, MD 20878, U.S.A
(Web) www.gl.com - (V) +1-301-670-4784 (F) +1-301-670-9187 - (E-Mail) info@gl.com

Testbed Configuration

The testbed setup window allow user to setup the required test configurations in N13 interface. It includes a list of variables that are declared and assigned before starting the script. Testbed Setup defines the MAPS™ parameters which communicates with the rest of the test network. End user configuration profile is used to configure MAPS™ 5G N13 interface with the supported UDM and AUSF parameters.

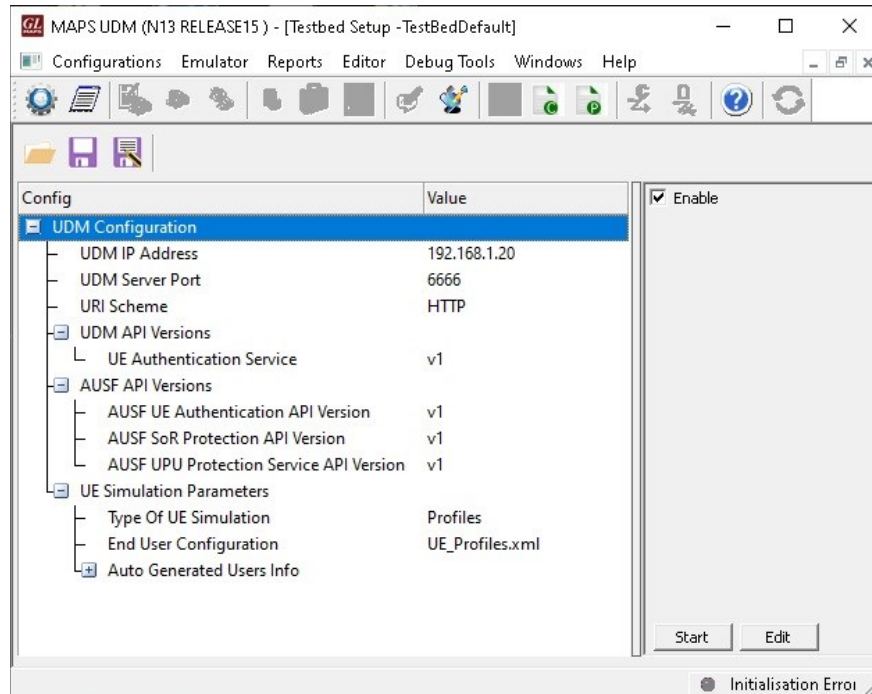

Figure: Testbed Setup

Pre-processing Tools

SCRIPT EDITOR - The script editor allow user to create/edit scripts and access protocol fields as variables for the message template parameters. The script uses pre-defined message templates, to perform send and receive actions.

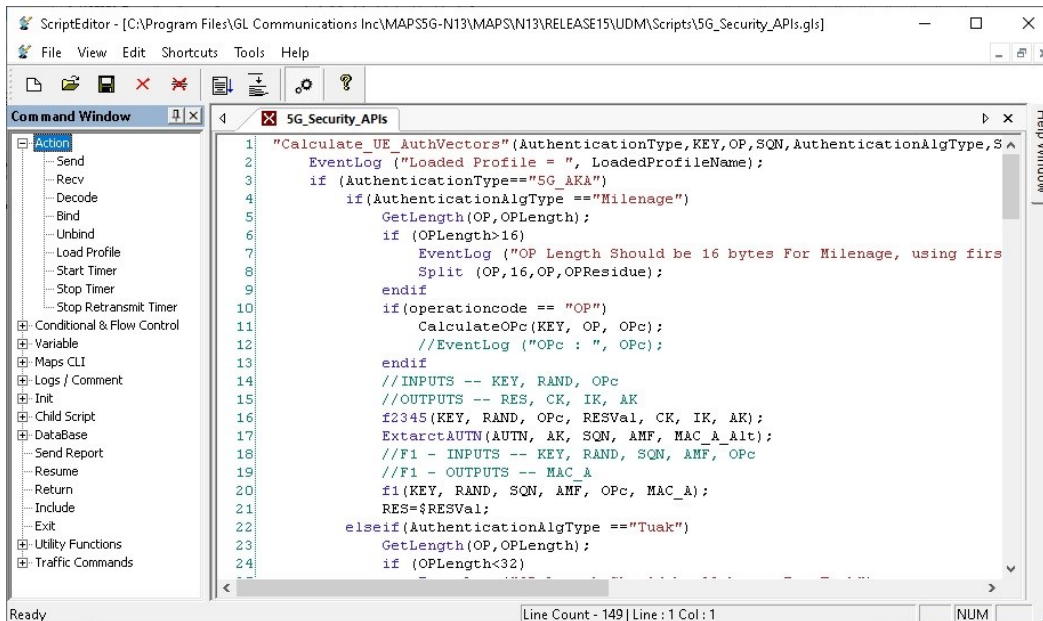

Figure: Script Editor

PROFILE EDITOR - This feature allow loading profile to edit the values of variables using GUI, replacing the original value of variables in the message template. An XML file defines a set of multiple profiles with varying parameter values which allow user to configure call instances in call generation to receive calls. The **UE_Profiles** include 5G parameters, that is required to configure multiple UEs to emulate Signaling and Traffic.

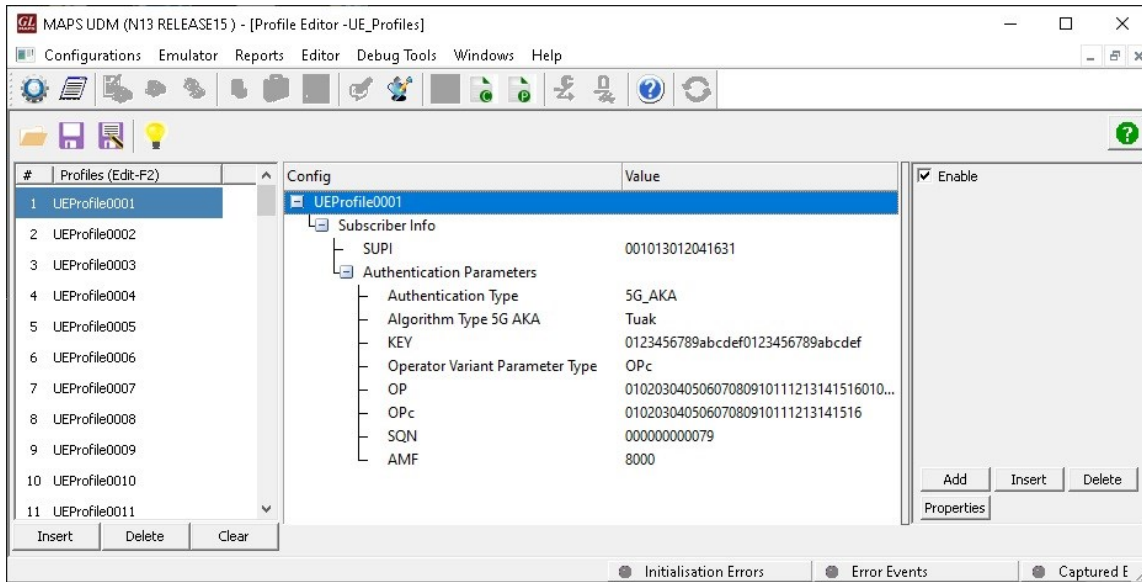

Figure: Profile Editor

Call Generation and Reception

In call generation mode, MAPS™ is configured for the outgoing messages, while in call receive mode, it is configured to respond to the incoming messages. Tests can be configured to run at once, multiple iterations and continuously. Also, allow user to create multiple entries using quick configuration feature. The editor allow to run the added scripts sequentially (order in which the scripts are added in the window) or randomly (any script from the list of added script as per the call flow requirements). The test scripts are started manually at call generation, and at the call reception the script is automatically triggered by incoming message.

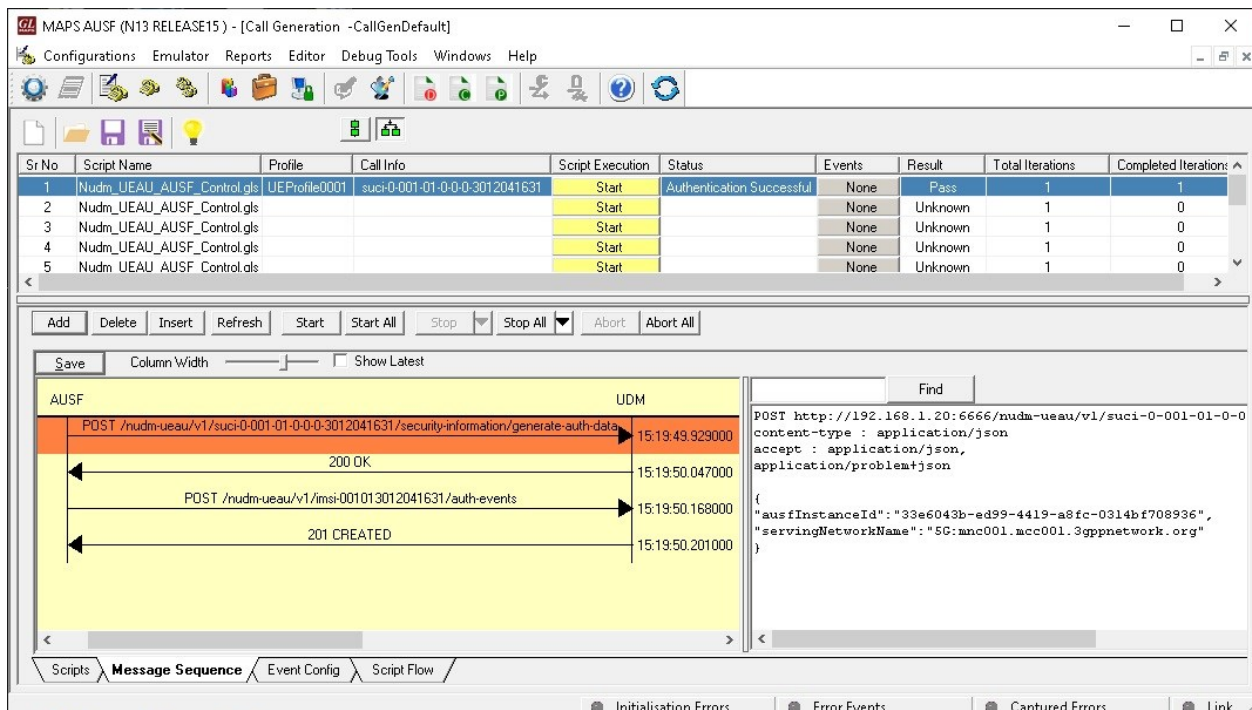

Figure: Call Generation

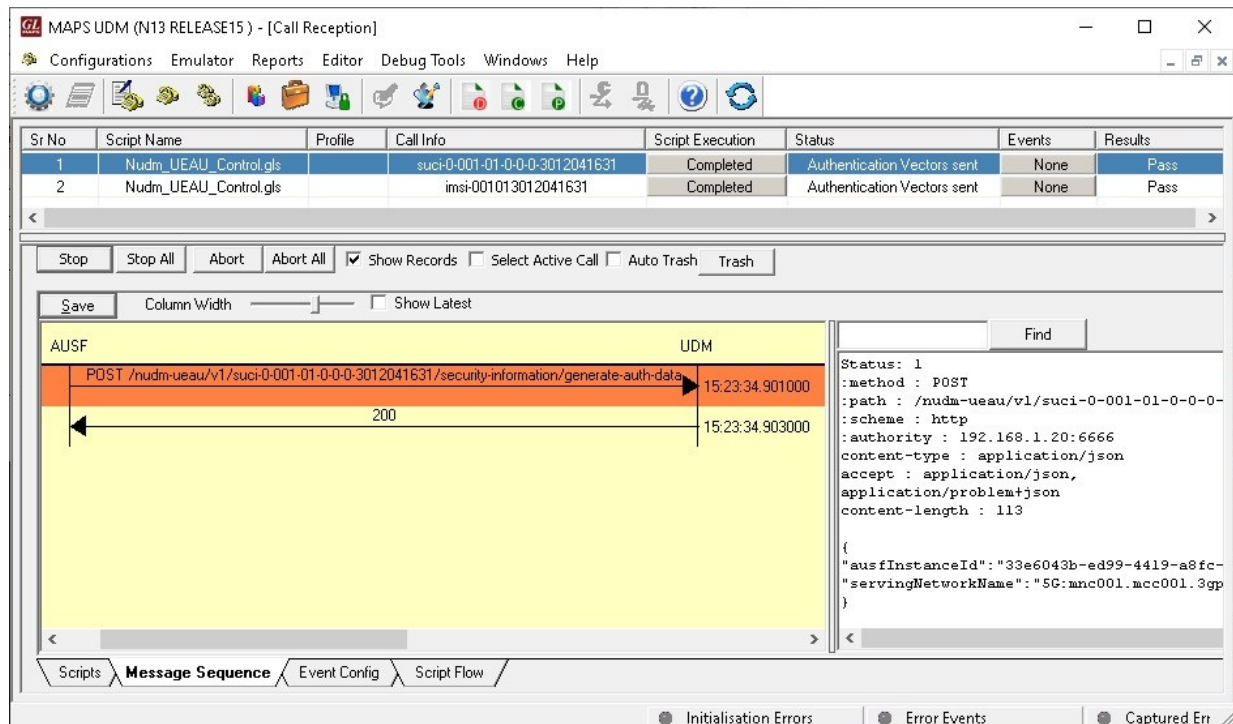

Figure: Call Reception

Nudm_UEAuthentication Service

Authentication Information Retrieval

MAPS™ for 5G N13 interface emulate services between UDM and AUSF network functions. An AUSF retrieves authentication information for the UE from UDM. The request contains the UE's identity (supi or suci), the serving network name, and may contain resynchronization info.

- An AUSF service consumer sends a POST request to the resource representing the UE's security information
- The UDM responds with "200 OK"
- If the operation cannot be authorized due to e.g UE does not have required subscription data, access barring or roaming restrictions, HTTP status code "403 Forbidden" should be returned including additional error information in the response body
- On **Failure**, the appropriate HTTP status code indicating the error shall be returned and appropriate additional error information should be returned in the POST response body

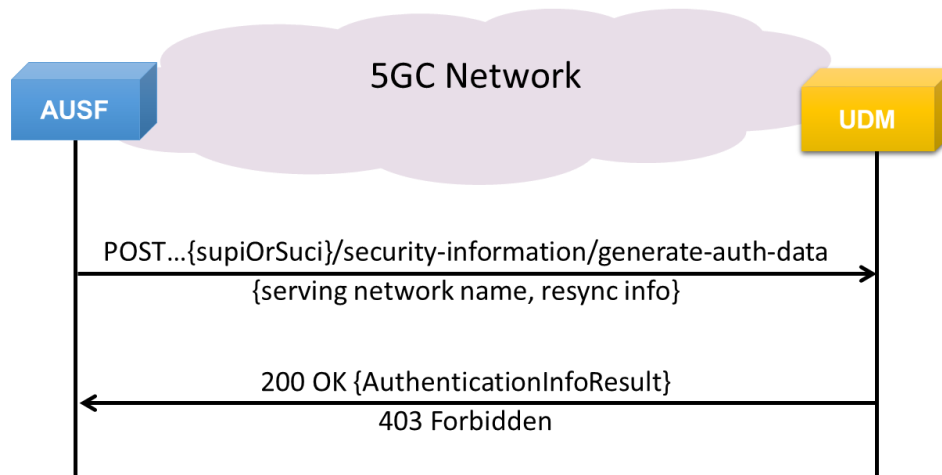

Nudm_UEAuthentication Service (Contd..)

Authentication Confirmation

MAPS™ for N13 interface emulate services between UDM and AUSF network functions. The AUSF confirms the occurrence of a successful or unsuccessful authentication to the UDM. The request contains the UE's identity (supi), and information about the authentication occurrence (AuthEvent).

- An AUSF service sends a POST request to the resource representing the UE's authentication events.
- On **Success**, the UDM responds with "201 Created".
- On **Failure**, the appropriate HTTP status code indicating the error shall be returned along with appropriate additional error information.

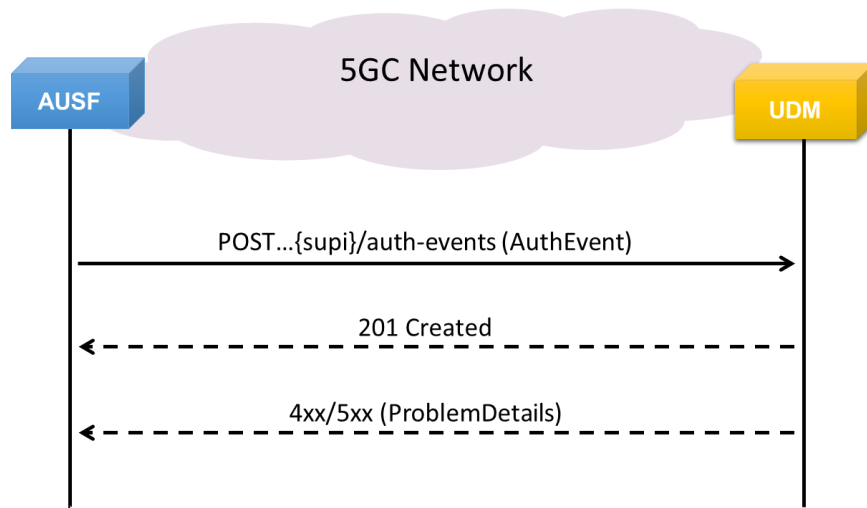

Authentication Result Removal

The AUSF service requests the UDM to remove the Authentication Result. The request contains the UE's identity (supi), the authEvent Id, and an indication to remove Authentication result.

- The AUSF service shall send a PUT request to the UDM. The payload of the body shall contain the indication to remove authentication result.
- On **Success**, "200 OK" shall be returned. The UDM shall remove the Authentication result of the UE by completely replacing the individual AuthEvent resource.
- On **Failure**, the appropriate HTTP status code indicating the error shall be returned and appropriate additional error information should be returned.

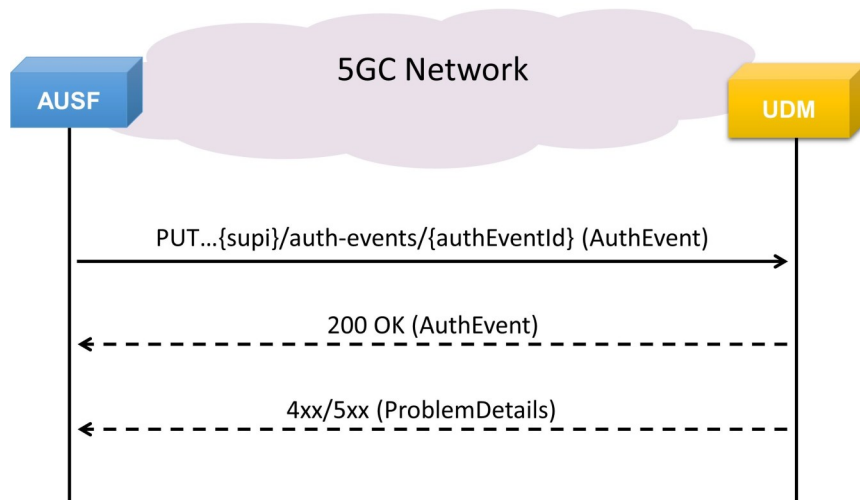

Supported Protocols and Specifications

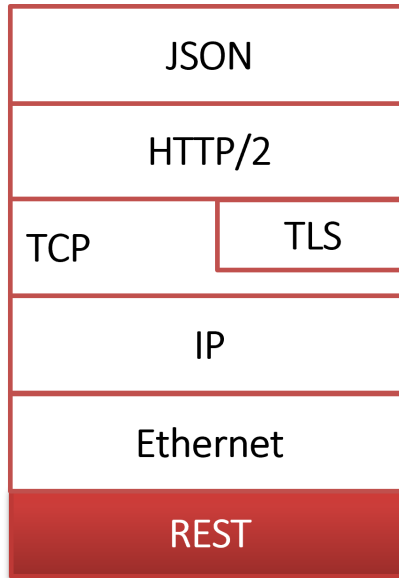

Supported Protocol	Standard/ Specification
N13 Interface (UDM - AUSF)	TS29.509 Release 17
JavaScript Object Notation (JSON)	IETF RFC 8259
HTTP2	IETF RFC 7231 IETF RFC 7540/RFC 7541
TLS	IETF RFC 8446
TCP	IETF RFC 793
IPv4	IETF RFC 791 [5] IETF RFC 2460 [6]

Buyer's Guide

Item No	Product Description
PKS507	MAPS™ 5G N13 Interface Emulator (Requires PKS502)
PKS305	MAPS™ 5G Multi-Interface Emulation

Item No	Related Software
PKS500	MAPS™ 5G N1/N2 Interface Emulator
PKS501	MAPS™ 5G N4 Interface Emulator
PKS502	5G service-based Emulation (Prerequisite base license for all service-based (Open API) interface emulations)
PKS503	MAPS™ 5G N8 Interface Emulator (Requires PKS502)
PKS504	MAPS™ 5G N10 Interface Emulator (Requires PKS502)
PKS505	MAPS™ 5G N11 Interface Emulator (Requires PKS502)
PKS506	MAPS™ 5G N12 Interface Emulator (Requires PKS502)
PKS502	MAPS™ 5G N17 Interface Emulator
PKS508	MAPS™ 5G N20 Interface Emulator (Requires PKS502)
PKS509	MAPS™ 5G N21 Interface Emulator (Requires PKS502)
PKS510	MAPS™ 5G N22 Interface Emulator (Requires PKS502)
PKS511	MAPS™ 5G N29 Interface Emulator (Requires PKS502)
PKS511	MAPS™ 5G N51 Interface Emulator (Requires PKS502)

For complete list of MAPS™ products, refer to [Message Automation & Protocol Simulation \(MAPS™\)](#) webpage.

For more details on supported MAPS™ 5G interfaces, refer to [5G Core \(5GC\) Network Test Solution](#) webpage.



GL Communications Inc.

818 West Diamond Avenue - Third Floor, Gaithersburg, MD 20878, U.S.A
 (Web) www.gl.com - (V) +1-301-670-4784 (F) +1-301-670-9187 - (E-Mail) info@gl.com