WAN Emulator – IPNetSim™

1 Gbps, 2.5 Gbps and 10 Gbps

Multi Stream IP WAN Emulator

 **GL Communications Inc.**

818 West Diamond Avenue - Third Floor, Gaithersburg, MD 20878
Phone: (301) 670-4784 Fax: (301) 670-9187 Email: info@gl.com
Website: <https://www.gl.com>

Typical Application

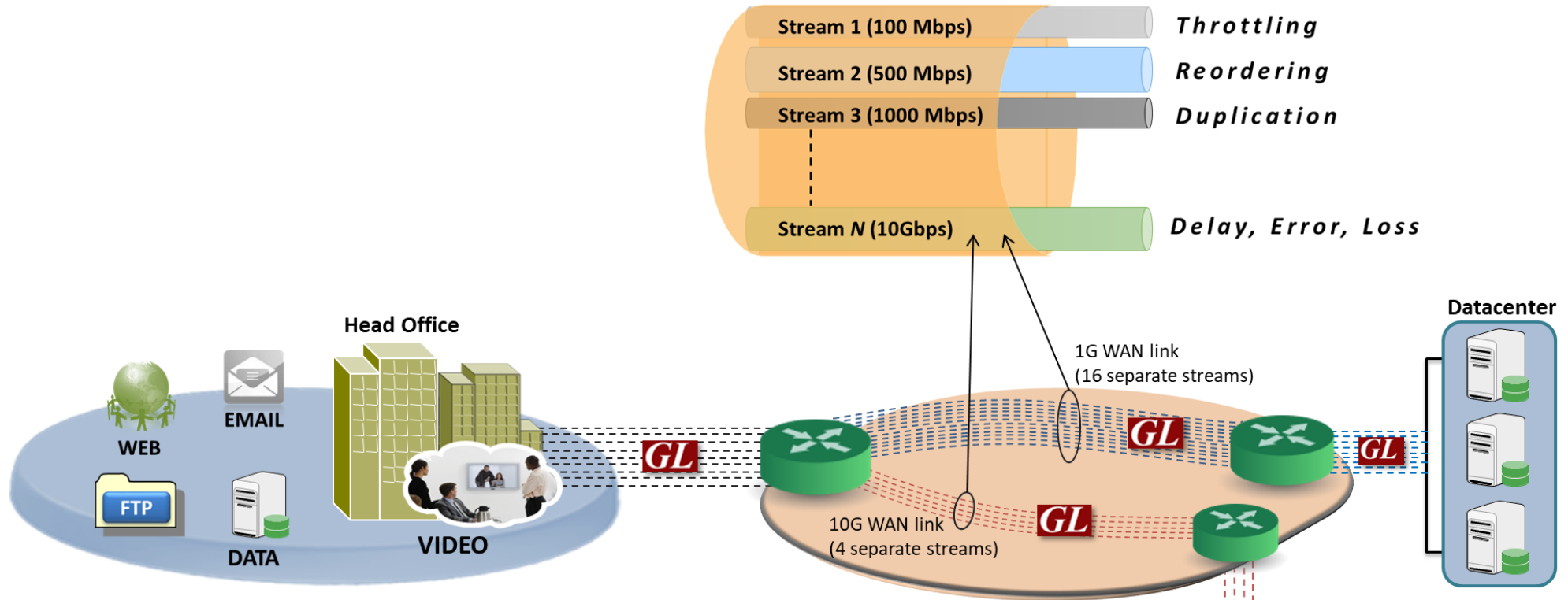

GL IPNetSim™ 10GX – IP WAN Link Emulator

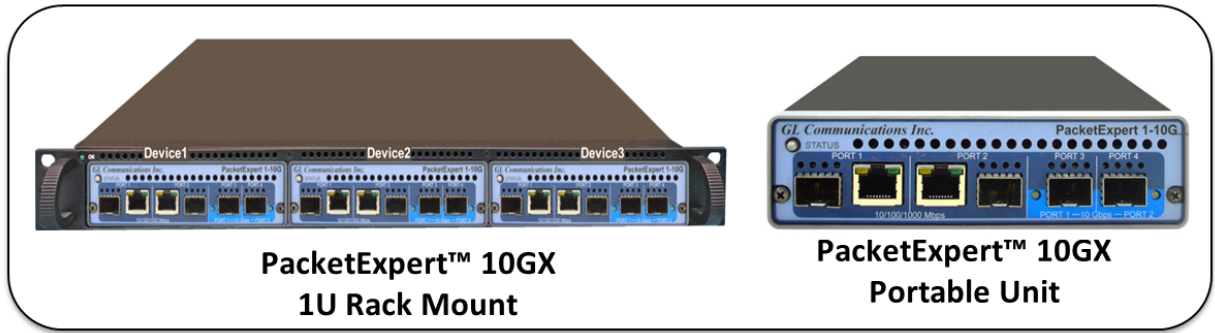

IPNetSim™

IPNetSim™ is an optional application available within PacketExpert™ platforms (PXG100 and PXN100).

- IPNetSim™ operates in both multi-stream and single stream mode.
- IPNetSim™ acts as a bridge between two network segments. As long as the hardware has power it allows frames to flow freely.
- IPNetSim™ allows users to define up to 16 different streams of traffic. Each of these streams can have its own independent set of impairments applied to them. More to come on streams and exactly how GL defines them.
- IPNetSim™ is hardware-based meaning all impairments and timing controls happen at the hardware level.

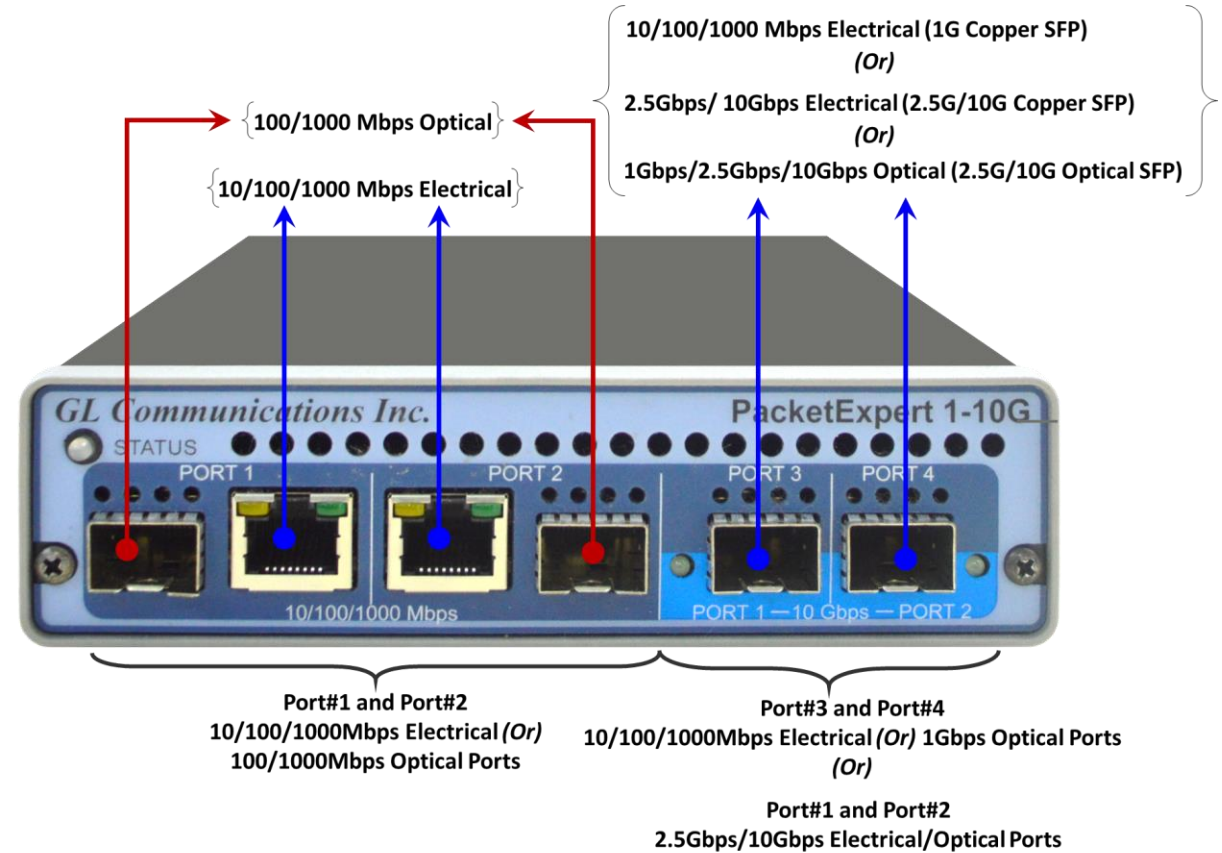

PacketExpert™ 10GX - Portable Unit (PXN100, PXN101)

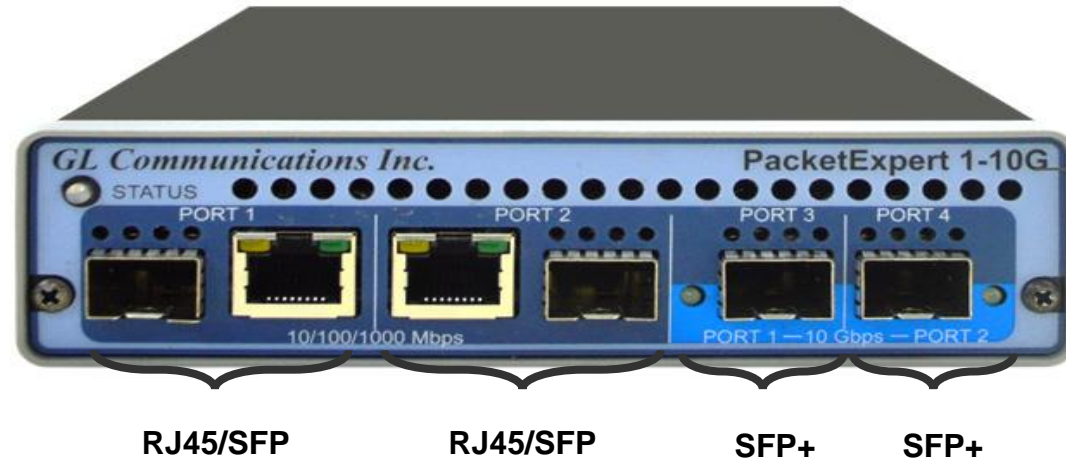

Physical Specifications	<ul style="list-style-type: none"> • Length: 8.45 in (214.63 mm) • Width: 5.55 in (140.97 mm) • Height: 1.60 in (40.64 mm) • Weight: 1.713 lbs
External Power Supply	<ul style="list-style-type: none"> • +12 Volts (Medical Grade), 3 Amps (For portable units having serial number ≥ 188400) • +9 Volts, 2 Amps (For portable units having serial number < 188400)
BUS Interface	<ul style="list-style-type: none"> • USB 3.0 • Optional 4-Port SMA Jack Trigger Board(TTL Input/Output)
Protocols	<ul style="list-style-type: none"> • IEEE 802.3ae LAN PHY compliance • RFC 2544 compliance

MTOP™ Rack Units



High Density 1U Rack option



Stacked High Density 1U Rack option

Physical Specifications	<ul style="list-style-type: none"> • Length: 16 in (406.4) • Width: 19 in (482.6) • Height: 1U / 2U
External Power Supply	<ul style="list-style-type: none"> • ATX Power Supply
BUS Interface	<ul style="list-style-type: none"> • 1U mTOP™ (MT001 + 3x PXN100) <ul style="list-style-type: none"> ➤ Rackmount Enclosure can support up to 3 PXN100s • 2U Rack Mount (with 6x PXN100) <ul style="list-style-type: none"> ➤ Rackmount Enclosure can support up to 6 PXN100s • Optional 4 to 12 Port SMA Jack Trigger Board (TTL Input/Output)
SBC Specifications	<ul style="list-style-type: none"> • Intel Core i3 or optional i7 NUC Equivalent, • Windows® 11 64-bit Pro Operating System • USB 3.0 and USB 2.0 Ports • USB Type C Ports, Ethernet 2.5GigE port • 256 GB Hard drive, 8G Memory (Min) • Two HDMI ports

mTOP™ Probe with 10GX Hardware Unit + SBC

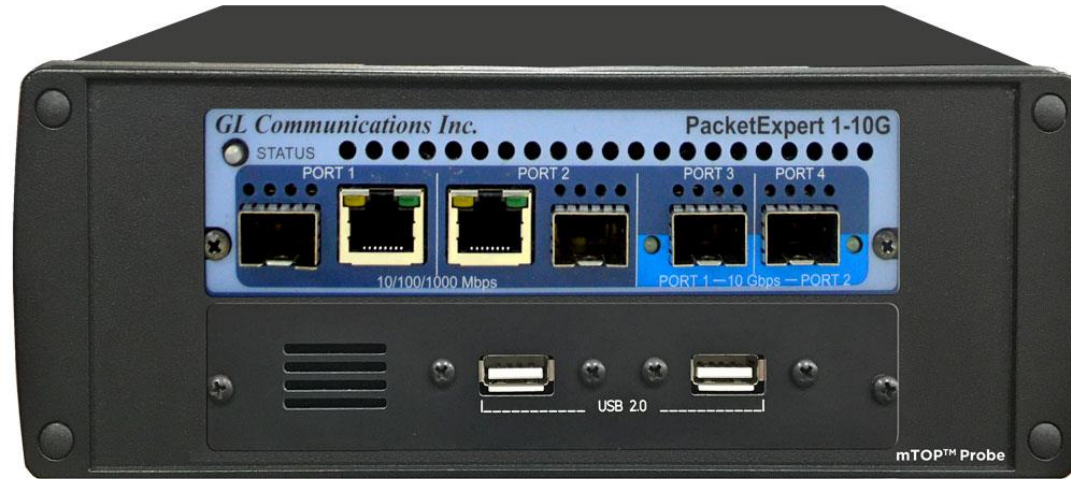

Physical Specifications	<ul style="list-style-type: none">• Length: 10.4 in. (264.16 mm)• Width: 8.4 in. (213.36 mm)• Height: 3.0 in. (76.2 mm)• Optional 4-Port SMA Jack Trigger Board (TTL Input/Output)• External USB based Wi-Fi adaptor
External Power Supply	<ul style="list-style-type: none">• +12 Volts (Medical Grade), 3 Amps
SBC Specifications	<ul style="list-style-type: none">• Intel Core i3 or optional i7 NUC Equivalent,• Windows® 11 64-bit Pro Operating System• USB 3.0 and USB 2.0 Ports• USB Type C Ports, Ethernet 2.5GigE port• 256 GB Hard drive, 8G Memory (Min)• Two HDMI ports

IPNetSim™

- Network Impairments: Bandwidth Control, Latency, Jitter, Packet Loss, Duplication, Reordering, Error Insertion
- Emulates Various Types of WAN Links (T1/E1/T3/E3/OC3/OC-2, DSL, Modem, etc)
- Multi-Streams (up to 16 Streams on 1G Ports and 4 Streams on 10G Ports) of varying Data Rates and Impairments
- Stream Definition Feature to Classify Traffic Flow into Separate Streams
- Raw and Packet Mode Stream Configurations
- Tx/Rx Frame Statistics for each Stream and Total Statistics per Port
- Command Line Interface for Automated Testing and Remote Accessibility
- Automated and Manual Impairment (scheduler)

IPNetSim™ Connectivity

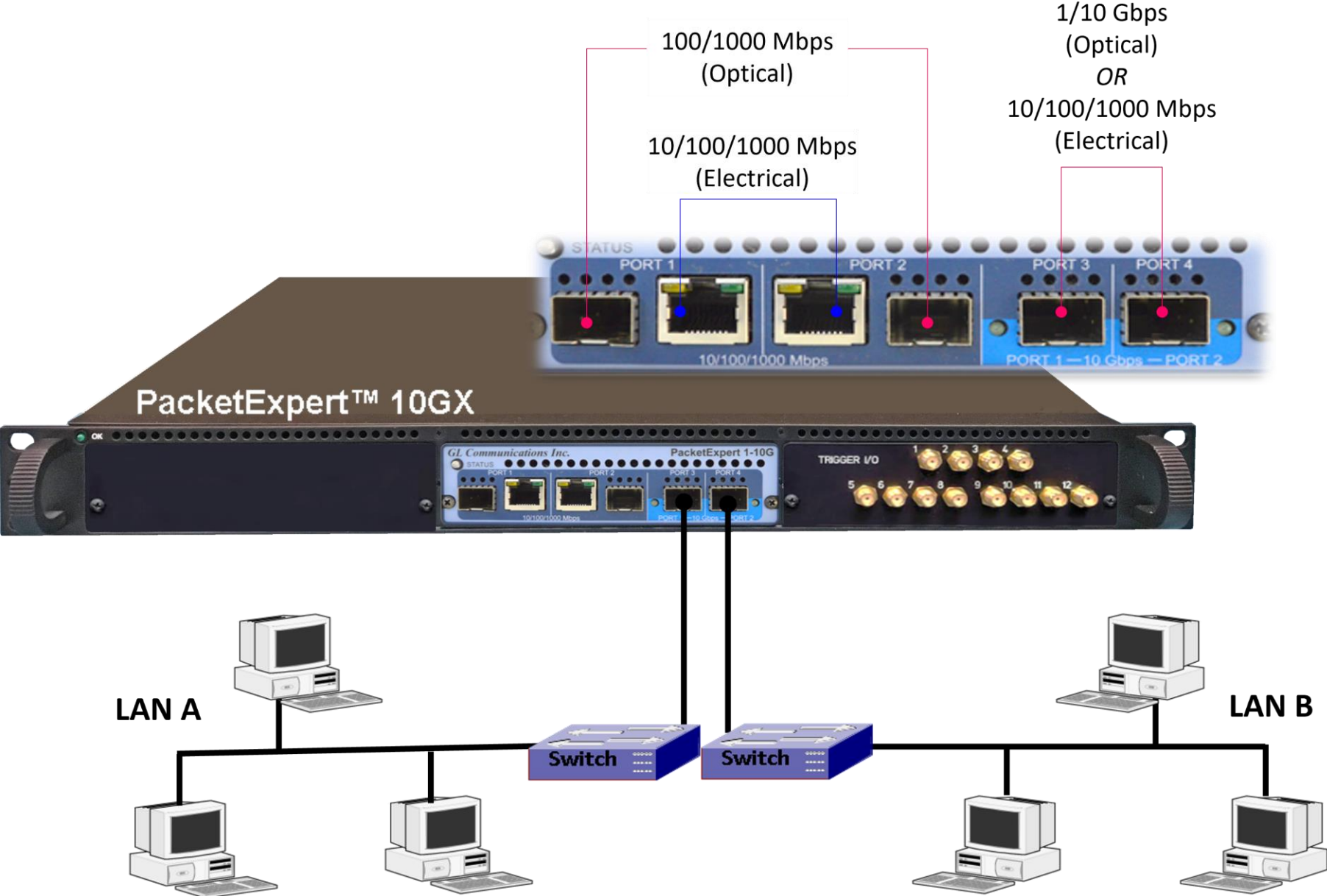

Software Specification

Stream Definition

- Hardware wire-speed filters (up to 16 links)
 - Packet Mode (field headers)
 - Raw Mode (bit level)
- Parameters
- IP Source and Destination Address Range
- UDP Source and Destination Port Range
- VMAC Addresses
- LAN ID
- MPLS Label

WAN Emulation Parameters

- Bandwidth control – 1 Kbps up to 10 Gbps
- Latency/Delay
 - 100 microseconds to 5000 milliseconds per stream (for 1 Gbps streams)
 - 100 microseconds to 1250 milliseconds (for 10/2.5 Gbps streams)
 - single delay, uniform, random distributions
- Packet Loss Rate - 0–50%
- Packet Reordering (Reorder between 0 and 50% of packets with a delay range of up to 2 seconds)
- Packet Duplication Rate - 0 - 50%
- Logic Error Insertion Rate - 10^{-1} to 10^{-9}
- Maximum Frame Size Supported – 2048 bytes

Stream Definition

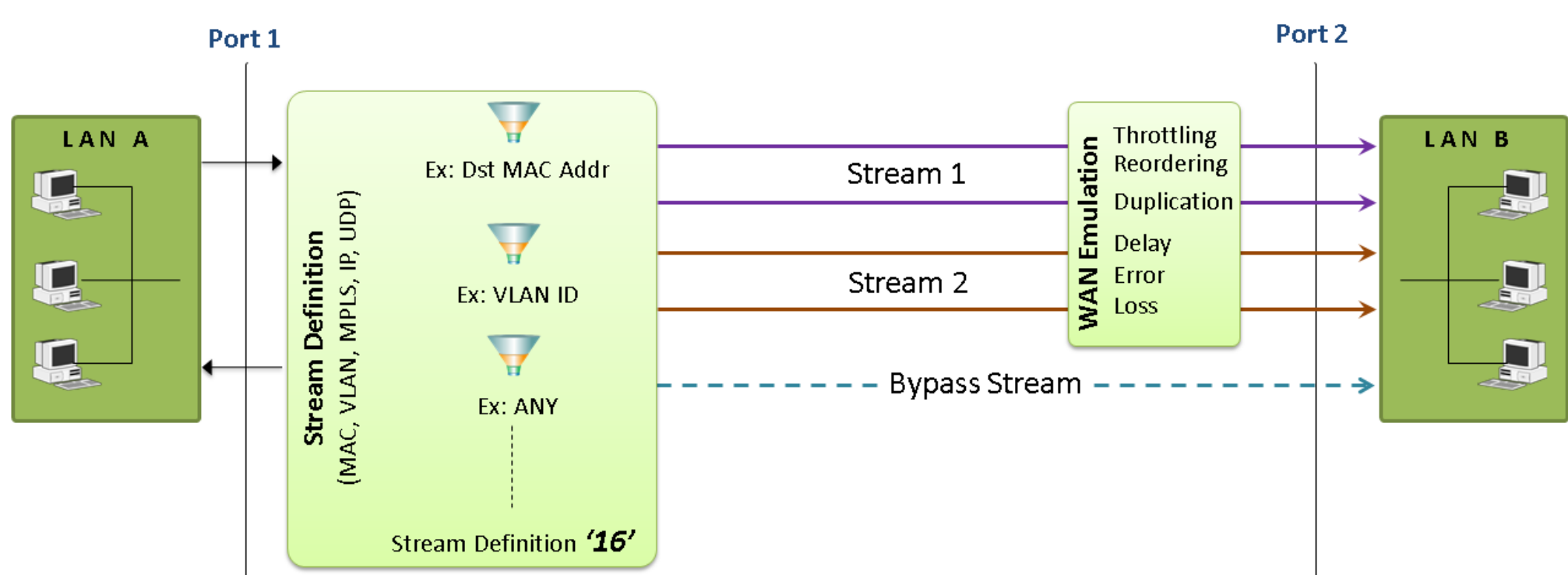

- IP Source and Destination Address Range
- UDP Source and Destination Port Range
- MAC Addresses
- VLAN ID
- MPLS Label

Stream Definition...

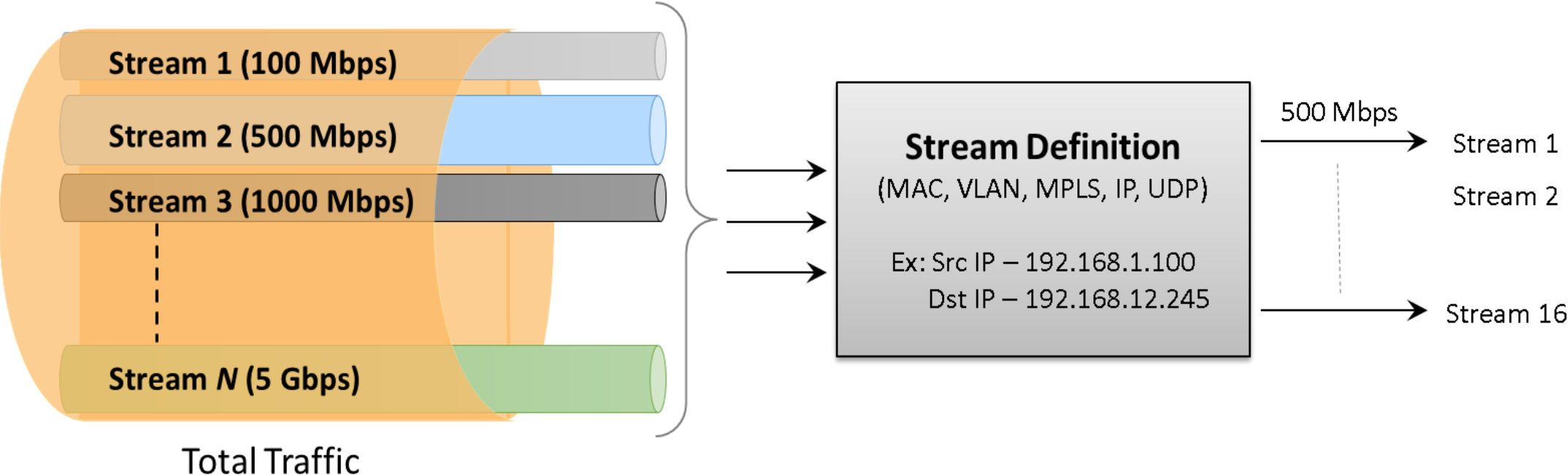

Stream Definition Configuration

Raw Mode

Stream Definition **WAN Emulation Parameters** Scheduler

P1 -> P2

Filter Mode
 Packet Mode Raw Mode Offset

Bytes	0	1	2	3	4	5	6	7
Byte 0-7	00	00	00	00	01	02	00	00
Byte 8-15	FF	FF	FF	FF	FF	FF	FF	FF

Apply

Bytes	Value	Mask
0-7	00 00 00 00 01 02 00 00	FF FF FF FF FF FF FF FF
8-15	00 00 00 00 00 00 00 00	00 00 00 00 00 00 00 00
16-23	00 00 00 00 00 00 00 00	00 00 00 00 00 00 00 00
24-31	00 00 00 00 00 00 00 00	00 00 00 00 00 00 00 00
32-39	00 00 00 00 00 00 00 00	00 00 00 00 00 00 00 00
40-47	00 00 00 00 00 00 00 00	00 00 00 00 00 00 00 00
48-55	00 00 00 00 00 00 00 00	00 00 00 00 00 00 00 00
56-63	00 00 00 00 00 00 00 00	00 00 00 00 00 00 00 00
64-71	00 00 00 00 00 00 00 00	00 00 00 00 00 00 00 00
72-79	00 00 00 00 00 00 00 00	00 00 00 00 00 00 00 00
80-87	00 00 00 00 00 00 00 00	00 00 00 00 00 00 00 00
88-95	00 00 00 00 00 00 00 00	00 00 00 00 00 00 00 00
96-103	00 00 00 00 00 00 00 00	00 00 00 00 00 00 00 00
104-111	00 00 00 00 00 00 00 00	00 00 00 00 00 00 00 00
112-119	00 00 00 00 00 00 00 00	00 00 00 00 00 00 00 00

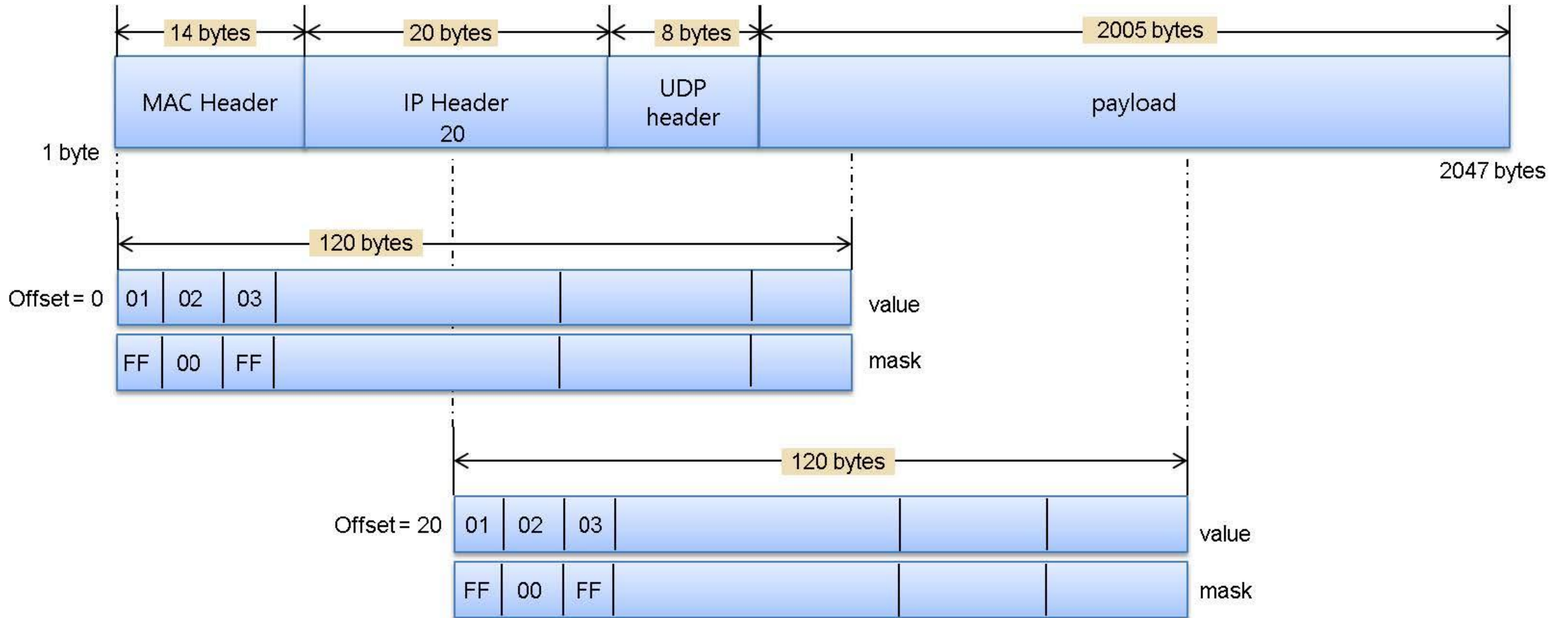

Ethernet Frame Structure

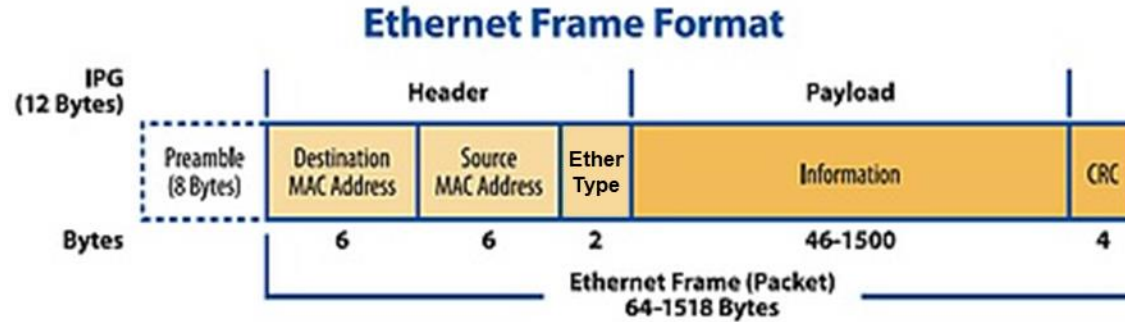
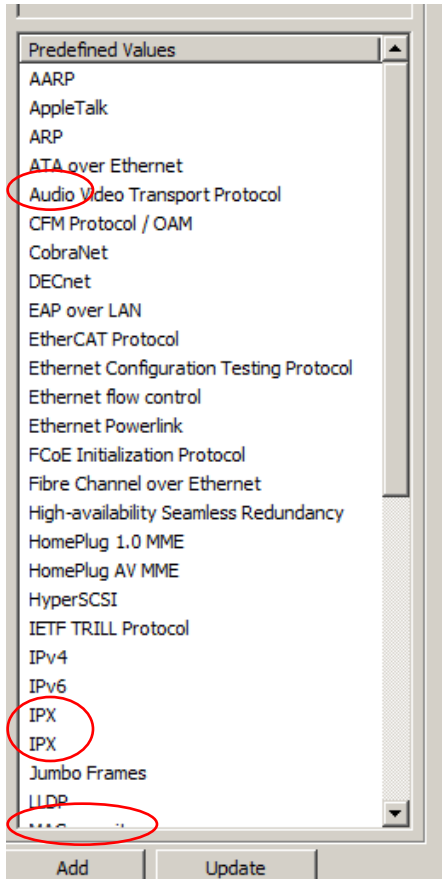

MAC: Media Access Control
 IPG: Inter-packet Gap
 CRC: Cyclic Redundancy Check

Switches Link Layer – physical addressing MAC,

802.3 Ethernet packet and frame structure

Layer	Preamble	Start of frame delimiter	MAC destination	MAC source	802.1Q tag (optional)	Ethertype (Ethernet II) or length (IEEE 802.3)	Payload	Frame check sequence (32-bit CRC)	Interpacket gap
	7 octets	1 octet	6 octets	6 octets	(4 octets)	2 octets	46(42) ^[b] –1500 octets	4 octets	12 octets
Layer 2 Ethernet frame	← 64–1518(1522) octets →								
Layer 1 Ethernet packet	← 72–1526(1530) octets →								

NIC - both a physical layer and data link layer device

Data Link

Ethernet Frame Structure

Open System Interconnection Model

Type IPV4 (0800)

Protocol - UDP

SIP Port 5060

RTP ports – even

RTCP ports - odd

1024-65534

RTP Version

Payload Type

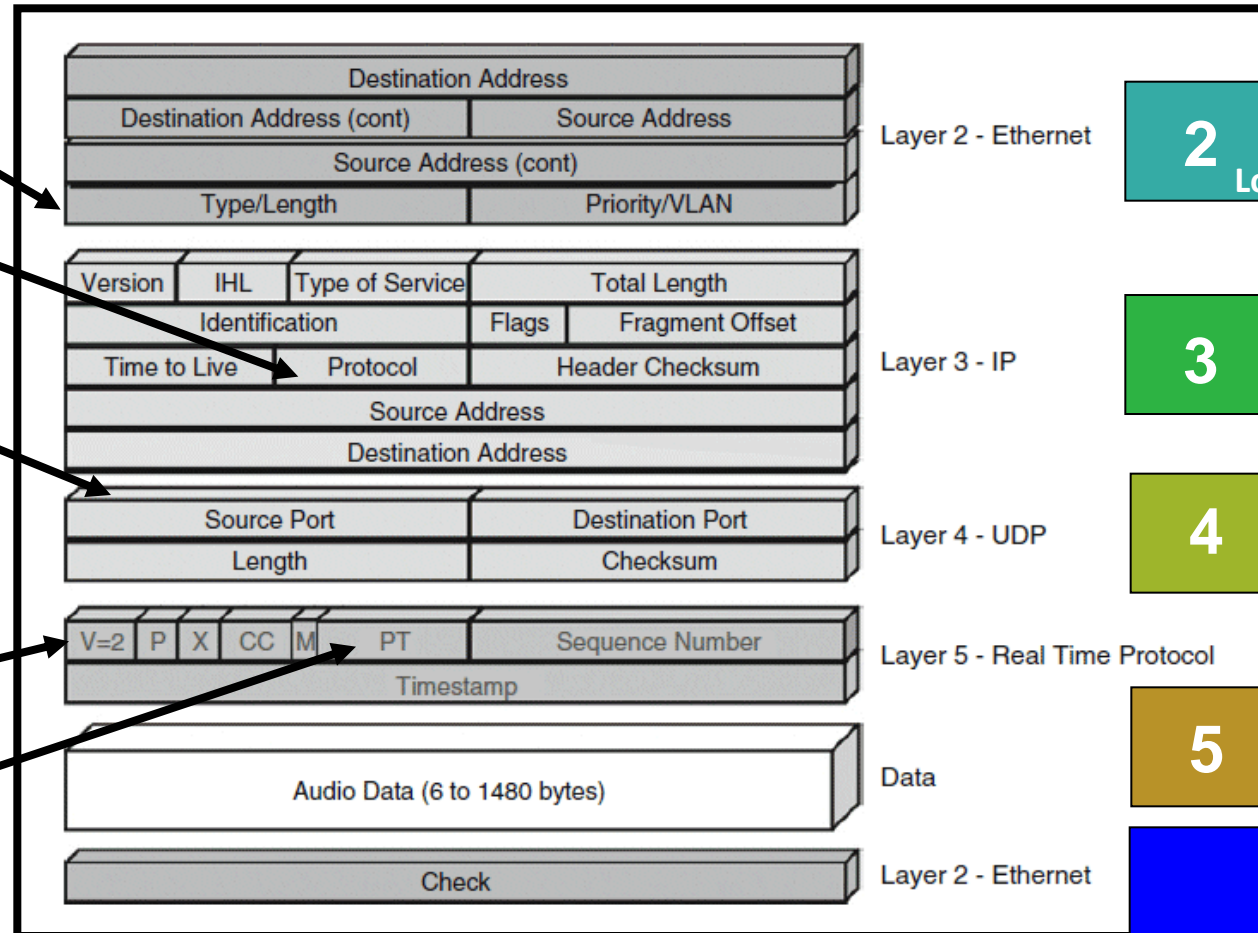

2 Data Link
Local Network Host Delivery

3 Network
Routing to Destination

4 Transport
Delivery and Sequenceing

5 Session
Establish connection

SIP RTP / RTCP
UDPTL

Stream Definition Configuration

Packet Mode

Stream Definition **WAN Emulation Parameters** Scheduler

P1 -> P2

Filter Mode
 Packet Mode Raw Mode

MAC VLAN MPLS IP UDP

Layer (Click to edit)	Layer Summary
MAC	00-00-00-00-01-01 -> 00-00-00-00-01-02, Len/Type = XX-XX
VLAN	VLAN Id = 0 , VLAN Stack = 1
MPLS	MPLS Label = 0 , MPLS Stack = 1
IP	192.168.1.11 - 192.168.1.16 --> 192.168.2.11 - 192.168.2.16

IPv4 IPv6

Source IP Address
 Fixed Range Any
From To

Destination IP Address
 Fixed Range Any
IP Address

Apply

WAN Emulation

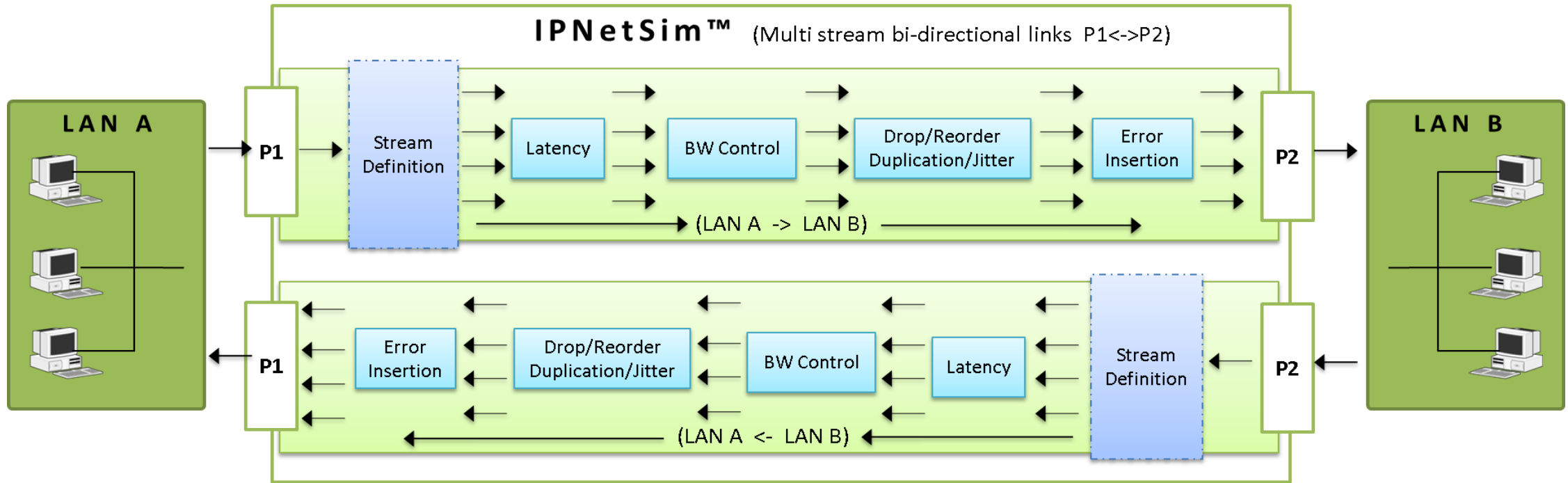

- Bandwidth control – 1 Kbps up to 10 Gbps
- Latency/Delay
 - 100 microseconds to 5000 milliseconds per stream (for 1 Gbps streams)
 - 100 microseconds to 1250 milliseconds (for 10/2.5 Gbps streams)
 - Single delay, Uniform, Random distributions
- Packet Loss Rate - 0–50%
- Packet Reordering Rate - 0-50% with Delay range of up to 2 seconds
- Packet Duplication Rate - 0 - 50%
- Logic Error insertion Rate - 10^{-1} to 10^{-9}
- Maximum Frame Size Supported – 2048 bytes

WAN Emulation Parameter Configurations

The screenshot shows the 'Stream Config' window with the 'WAN Emulation Parameters' tab selected. The 'WAN Stream Type' is set to 'Symmetrical'. Below this, a table lists parameters for P1 -> P2 and P2 -> P1 directions. The 'Logic Error Insertion' section for P1 -> P2 shows a 'Rate' of 'Periodic' and a 'Packet Error Rate' of 10^{-3} .

Parameters	P1 -> P2	P2 -> P1
Traffic Bandwidth	10000.00 Mbps	10000.00 Mbps
Latency	Uniform, 0.000 msec - 500.000 msec	Uniform, 0.000 msec - 500.000 msec
Packet Loss	10.000 %	10.000 %
Packet Reordering	1 out of 1 packets	1 out of 1 packets
Packet Duplication	20.000 %	20.000 %
Logic Error Insertion	10^{-3}	10^{-3}

P1 -> P2
Logic Error Insertion
Rate
 Periodic Random
Packet Error Rate: 10^{-3}
Bytes Offset: 10 Beginning of frame
Bytes Offset: 20 End of frame

The screenshot shows the 'Stream Config' window with the 'WAN Emulation Parameters' tab selected. The 'WAN Stream Type' is set to 'Asymmetrical'. Below this, a table lists parameters for P1 -> P2 and P2 -> P1 directions. The 'Logic Error Insertion' sections for both directions show different 'Packet Error Rate' values: 10^{-3} for P1 -> P2 and 10^{-2} for P2 -> P1.

Parameters	P1 -> P2	P2 -> P1
Traffic Bandwidth	10000.00 Mbps	10000.00 Mbps
Latency	Uniform, 0.000 msec - 500.000 msec	Single Delay, 100.000 msec
Packet Loss	10.000 %	15.000 %
Packet Reordering	1 out of 1 packets	1 out of 5 packets
Packet Duplication	20.000 %	30.000 %
Logic Error Insertion	10^{-3}	10^{-2}

P1 -> P2
Logic Error Insertion
Rate
 Periodic Random
Packet Error Rate: 10^{-3}
Bytes Offset: 10 Beginning of frame
Bytes Offset: 20 End of frame

P2 -> P1
Logic Error Insertion
Rate
 Periodic Random
Packet Error Rate: 10^{-2}
Bytes Offset: 0 Beginning of frame
Bytes Offset: 0 End of frame

- **Symmetrical** option allows users to configure bidirectional streams with identical WAN impairments in both the directions
- **Asymmetrical** option allows users to configure bidirectional streams with different WAN impairments in each direction

PacketLoss

- Packet loss is to simulate the devices causing the overload network or underperforming network conditions. Packet loss model includes Periodic and Random Packet loss options
 - In **Periodic** option, packet drops occur at regular intervals, making the loss predictable
 - In **Random** option, packets being dropped randomly without any specific pattern
 - **Packet Loss Rate:** Packets are selected to drop at regular intervals/events based on the number of received packets.
 - **Window Size:** Flexible Packet dropping configuration, customize Minimum Frames, Maximum Frames, and Drop After Packets to control intentional packet drops.

The screenshot shows the 'Stream Config' interface with the 'WAN Emulation Parameters' tab selected. A table lists parameters for P1->P2 and P2->P1 directions. The 'Packet Loss' row is highlighted in red, showing a 1.000% rate for both directions. Below the table, two configuration panels for 'Packet Drop Interval' are shown, one for P1->P2 and one for P2->P1. Both panels have 'Random' selected under 'Packet Drop Interval' and 'Rate' selected under 'Rate'. A warning message is displayed in both panels, stating that the Packet Loss Rate range is between 0.002% to 50% and that entered values must be in multiples of 0.002%. The rate is set to 1.000% in both panels, with a note that 1 packet will be dropped for 100 packets.

Parameters	P1 -> P2	P2 -> P1
Traffic Bandwidth	10000.00 Mbps	10000.00 Mbps
Latency	Single Delay, 10.000 msec	Single Delay, 10.000 msec
Packet Loss	1.000 %	1.000 %
Packet Reordering	None	None
Packet Duplication	None	None
Logic Error Insertion	None	None

P1 -> P2 Packet Loss Configuration:
Packet Drop Interval: Periodic Random
Rate: Rate Window
Rate: 1.000 %
1 packet will be dropped for 100 packets

P2 -> P1 Packet Loss Configuration:
Packet Drop Interval: Periodic Random
Rate: Rate Window
Rate: 1.000 %
1 packet will be dropped for 100 packets

Packet Reordering

- Packet reordering model includes Periodic and Random Packet Reordering options
- In **Periodic** option, the packets are reordered at constant specified rate
- While in **Random** option, packets are randomized for reordering, but still maintain the specified Reorder rate

The screenshot shows the 'WAN Emulation Parameters' tab in a configuration tool. It features a table of parameters for two directions: P1 -> P2 and P2 -> P1. Below the table are detailed configuration panels for 'Packet Reordering' and 'Delay Offset' for each direction.

Parameters	P1 -> P2	P2 -> P1
Traffic Bandwidth	10000.00 Mbps	10000.00 Mbps
Latency	Uniform, 0.000 msec - 500.000 msec	Single Delay, 100.000 msec
Packet Loss	5.000 %	10.000 %
Packet Reordering	1 out of 1 packets	1 out of 5 packets
Packet Duplication	20.000 %	30.000 %
Logic Error Insertion	10 ⁻³	10 ⁻²

P1 -> P2 Packet Reordering: Periodic Random. Reorder 1 packet out of 1 packets.

P1 -> P2 Delay Offset: Time Frames. Min 0 ms, Max 0 ms.

P2 -> P1 Packet Reordering: Periodic Random. Reorder 1 packet out of 5 packets.

P2 -> P1 Delay Offset: Time Frames. Min 0 ms, Max 0 ms.

Packet Duplication

- Packet Duplication model also includes Periodic and Random Packet Duplication options
- In **Periodic Duplication** option, the packets are duplicated at specified rate periodically
- In **Random Duplication** option, the selected packet is duplicated (based on the rate) randomly but maintaining the duplication rate

The screenshot shows the 'Stream Config' interface with the 'WAN Emulation Parameters' tab selected. The 'WAN Stream Type' is set to 'Asymmetrical'. A table below shows parameters for P1->P2 and P2->P1. The 'Packet Duplication' row is highlighted with a red border, showing a rate of 1.000% for both directions. Below the table, there are two configuration panels for 'P1 -> P2' and 'P2 -> P1', each with a 'Duplication' section. Both panels show a 'Rate' of 1.000% and the 'Random' option selected. A warning message is displayed in each panel, stating: 'WARNING: Packet Duplication Rate range is between 0.002% to 50%. For rates between 0.002% and 0.098%, entered values must be in multiples of 0.002%. Eg: 0.002%, 0.004%, 0.006% and so on till 0.098%'.

Parameters	P1 -> P2	P2 -> P1
Traffic Bandwidth	10000.00 Mbps	10000.00 Mbps
Latency	None	None
Packet Loss	None	None
Packet Reordering	None	None
Packet Duplication	1.000 %	1.000 %
Logic Error Insertion	None	None

Error Insertion

Stream Definition | **WAN Emulation Parameters** | Scheduler

WAN Stream Type Symmetrical Asymmetrical

Parameters	P1 -> P2	P2 -> P1
Traffic Bandwidth	10000.00 Mbps	10000.00 Mbps
Latency	Uniform, 0.000 msec - 500.000 msec	Single Delay, 100.000 msec
Packet Loss	5.000 %	10.000 %
Packet Reordering	1 out of 1 packets	1 out of 5 packets
Packet Duplication	20.000 %	30.000 %
Logic Error Insertion	10 ⁻³	10 ⁻⁵

P1 -> P2

Logic Error Insertion

Rate

Periodic Random

Packet Error Rate: 10⁻³

Bytes Offset: 5 Beginning of frame

Bytes Offset: 10 End of frame

P2 -> P1

Logic Error Insertion

Rate

Periodic Random

Packet Error Rate: 10⁻⁵

Bytes Offset: 15 Beginning of frame

Bytes Offset: 20 End of frame

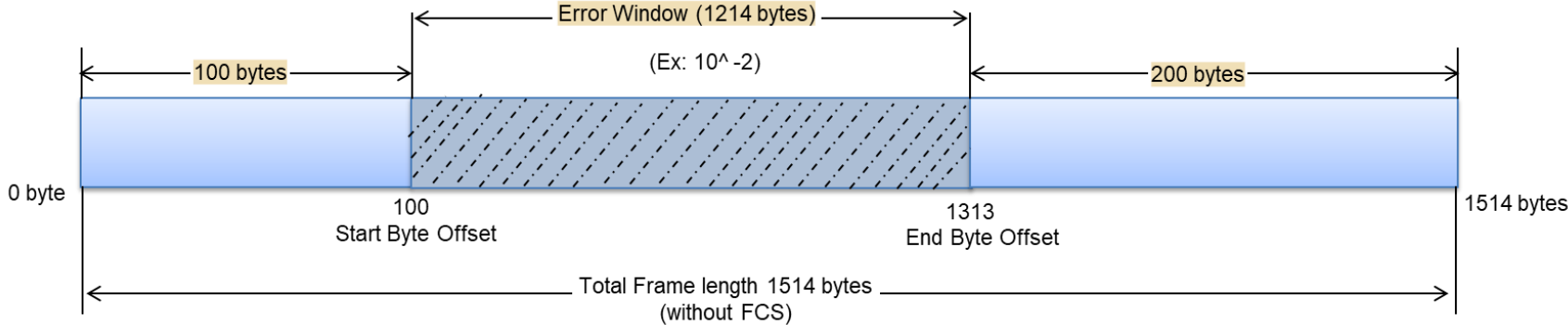

Impairment Scheduler

- Scheduler feature to automate stream impairment.
- Scheduler reads Packet Loss(%), Latency(msec), and Bandwidth(Mbps) impairment values from a compatible csv file (generated from MTGA application) for both the link directions (P1→P2) and (P2→P1), which can be used to impair the selected stream. The applied impairment for each stream can be viewed graphically as well.

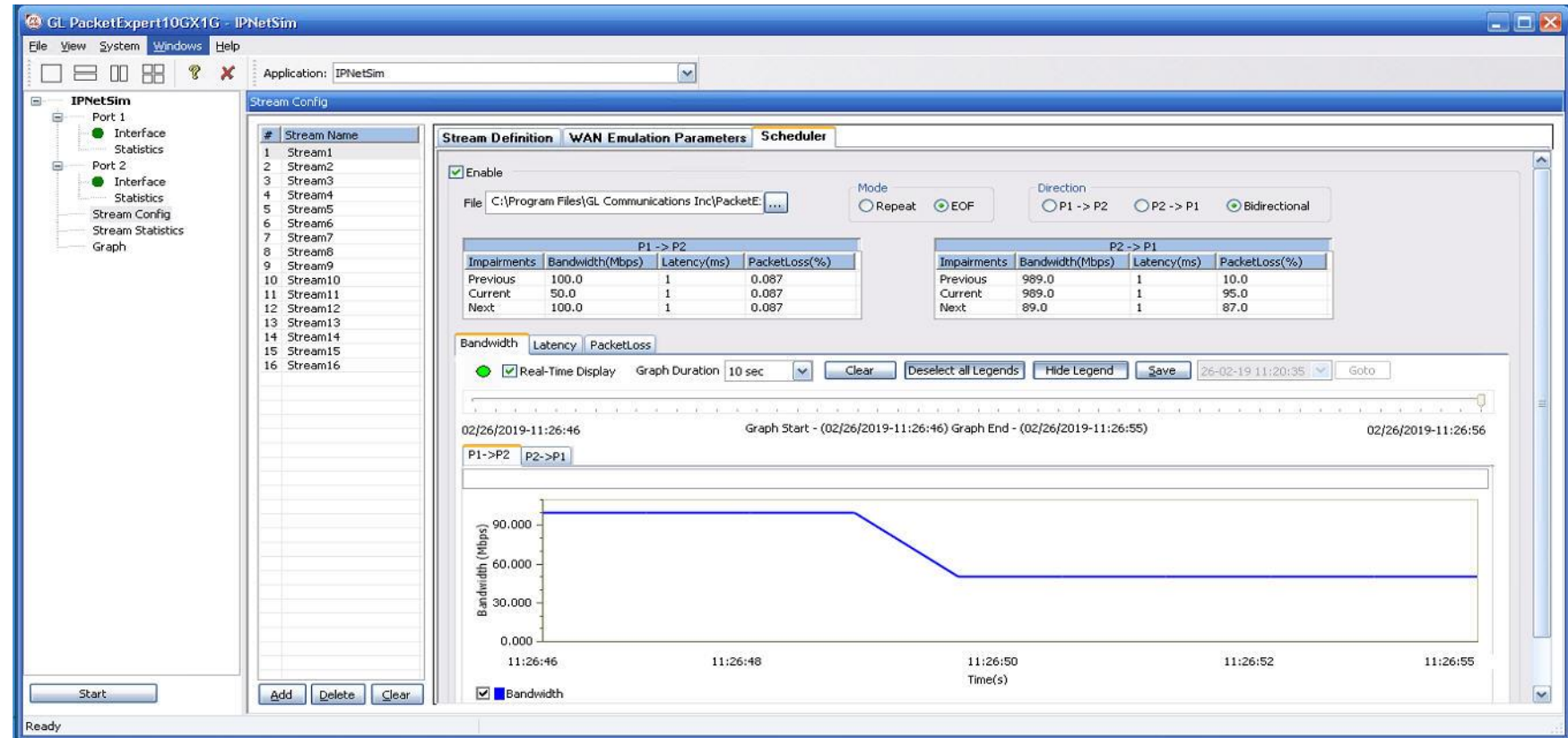

The Bandwidth (Mbps) graph plotted against Time (Sec) for the selected stream as per the values defined in the csv file.

Stream and Port Statistics

Stream Statistics (16 streams on 1G ports)

#	Stream Name	Statistic	Value P1->P2	Percent P1->P2	Value P2->P1	Percent P2->P1
1	Stream1	Tx Bytes	913 733 822	NA	986 732 846	NA
2	Stream2	10 Sec Average Throughput	108.935	NA	117.616	NA
3	Stream3	1 Min Average Throughput	0.000	NA	0.000	NA
4	Stream4	10 Min Average Throughput	0.000	NA	0.000	NA
5	Stream5					
6	Stream6	Rx Frames	651 674	NA	5 430 036	NA
7	Stream7	Tx Frames	603 523	NA	651 739	NA
8	Stream8					
9	Stream9	Dropped Packets (Bandwidth C...	97 474	14.957	4 877 352	89.822
10	Stream10	No Of Packets With Errors	602	0.092	65	0.001
11	Stream11	Dropped Packets (Packet Loss)	5 542	0.850	11 084	0.204
12	Stream12	Duplicated Packets	54 865	8.419	108 623	2.000
13	Stream13	Reordered Packets	603 523	92.611	108622	2.000
14	Stream14					
15	Stream15					
16	Stream16					

Stream Statistics (4 streams on 10G ports)

#	Link Name	Statistic	Value P1->P2	Percent P1->P2	Value P2->P1	Percent P2->P1
1	Stream1	Tx Bytes	86 833 789 480	NA	77 444 882 692	NA
2	Stream2	10 Sec Average Throughput	9999.971	NA	8916.056	NA
3	Stream3	1 Min Average Throughput	9999.978	NA	8916.063	NA
4	Stream4	10 Min Average Throughput	0.000	NA	0.000	NA
		Rx Frames	42 395 938	NA	42 366 224	NA
		Tx Frames	42 397 628	NA	37 813 319	NA
		Dropped Packets (Bandwidth C...	0	0.000	0	0.000
		No Of Packets With Errors	42 358	0.100	3 781	0.009
		Dropped Packets (Packet Loss)	2 028 703	4.785	6 355 530	15.001
		Duplicated Packets	3 854 756	9.092	1 800 836	4.251
		Reordered Packets	0	0.000	0	0.000

Port Statistics		
Port Selection	Port 2	Reset
Description	Tx	Rx
Total Frames	644 980 425	644 980 425
Valid Frames	644 980 425	644 980 425
Bad Frames	0	0
Number Of Bytes	978 923 722 606	978 923 722 606
Link Utilisation(%)	0.000	0.000
Data Rate(Mbps)	0.000	0.000
Frame Rate(Frames/sec)	0	0
Non Test Frames	0	123
Broadcast Frames	62	62
Multicast Frames	644 980 363	61
Control Frames	0	0
VLAN Frames	0	0
Pause Frames	0	0
Wrong Opcode Frames	0	0
Out of Bound Frames	0	0
Length Type Out of Range Frames	0	0
64 Byte Length Frames	61	61
65-127 Byte Length Frames	107 913	107 913
128-255 Byte Length Frames	0	0
256-511 Byte Length Frames	0	0
512-1023 Byte Length Frames	0	0
1024-1518 Byte Length Frames	644 872 451	644 872 451
Oversized Frames	0	0
Undersized Frames	-	0
FCS Error Frames	-	0
1 Level Stacked VLAN Frames	-	0
2 Level Stacked VLAN Frames	-	0
3 Level Stacked VLAN Frames	-	0
1 Level Stacked MPLS Frames	-	0
2 Level Stacked MPLS Frames	-	0
3 Level Stacked MPLS Frames	-	0
IP Checksum Errors	-	0
IPv4 Packets	-	644 980 302
IPv6 Packets	-	0
IP in IP Packets	-	0
UDP in IP Packets	-	0
TCP in IP Packets	-	644 980 302
ICMP in IP Packets	-	0
IGMP in IP Packets	-	0
IGRP in IP Packets	-	0
Other Protocol in IP Packets	-	0
UDP Checksum Errors	-	0
UDP Packets	-	0

Stream Throughput Graph

4 streams on 10G ports

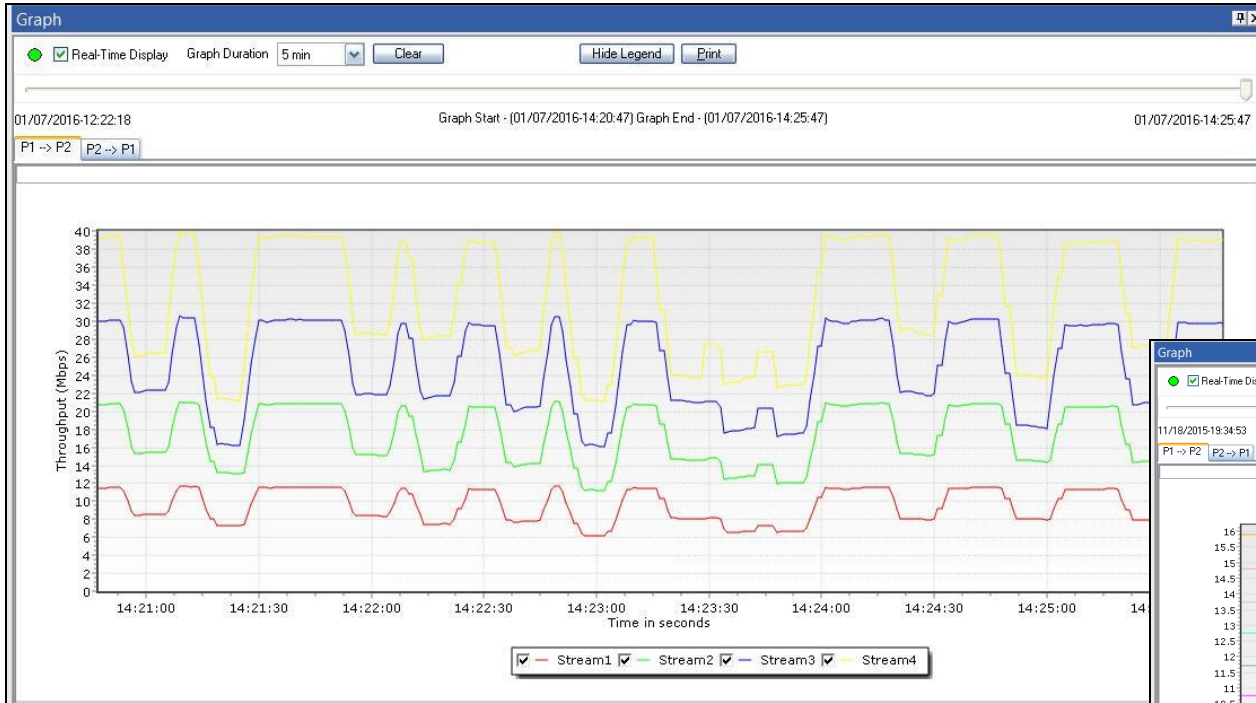

16 streams on 1G ports

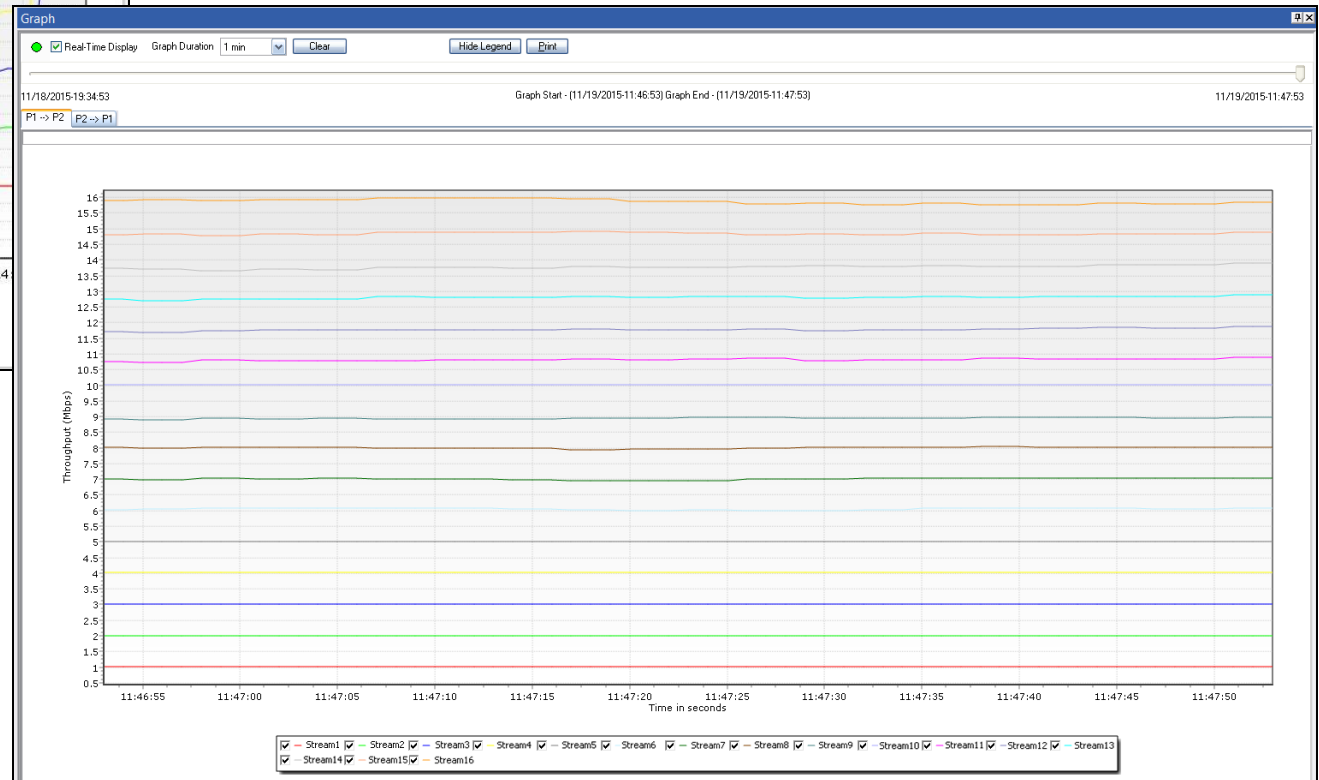

Satellite Network Link Emulation

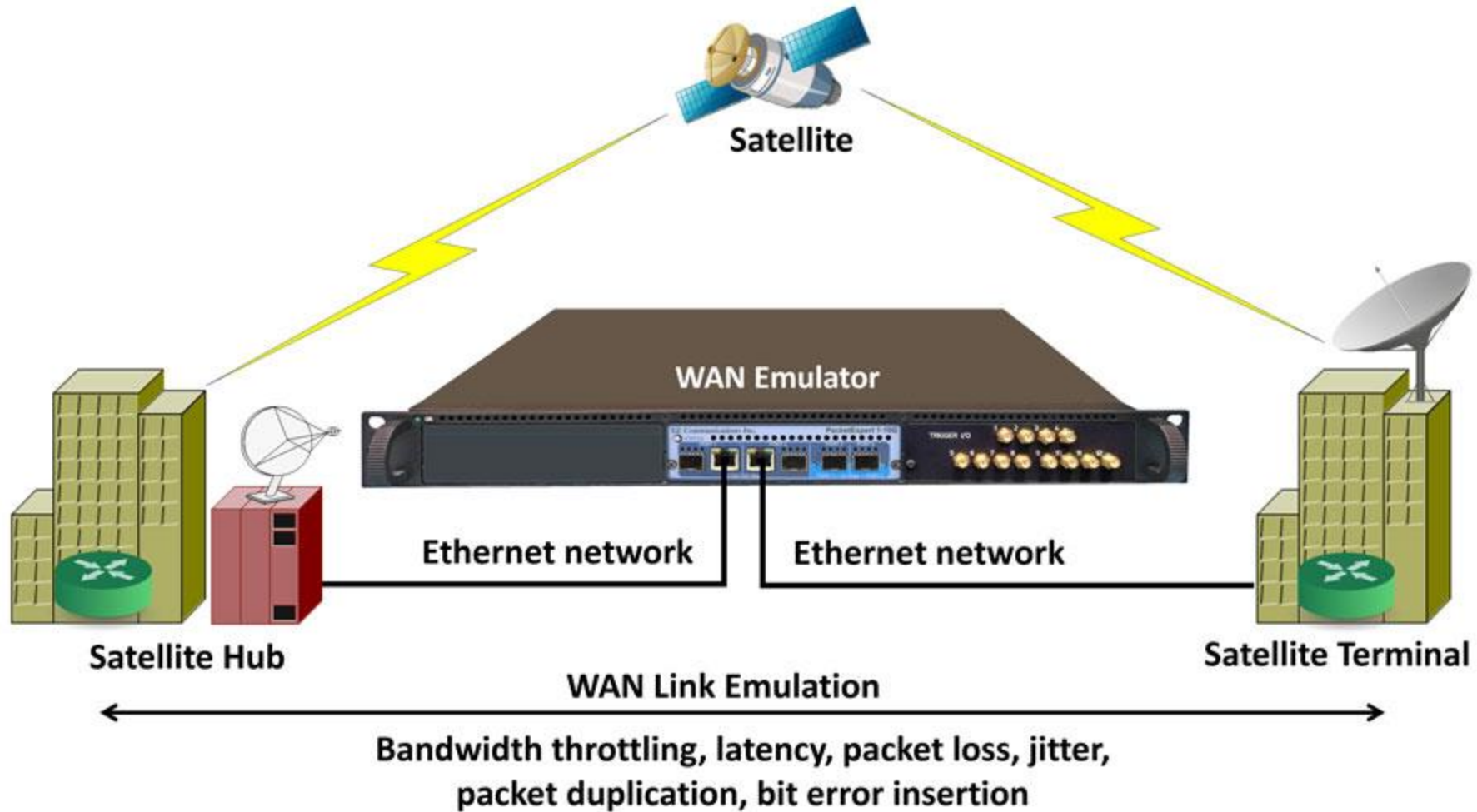

Thank you