

ITU-T Y.1564 ExpertSAM™ (1Gbps)

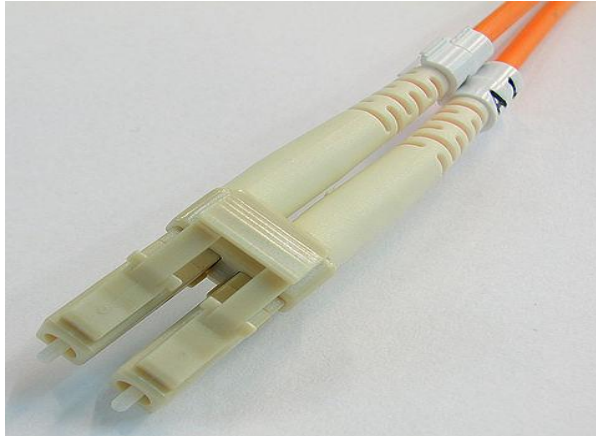

818 West Diamond Avenue - Third Floor, Gaithersburg, MD 20878
Phone: (301) 670-4784 Fax: (301) 670-9187 Email: info@gl.com
Website: <https://www.gl.com>

Optical Connectors and SFP Transceivers

LC Connectors



850nm/1310nm/1550nm

SFP Module



- PacketExpert™ supports LC connectors and 850nm/1310nm/1550nm SFP (Small Factor Pluggable) modules

Note: In case customer have different type of connectors, then we need converters like LC-to-SC, LC-to-FC and vice-versa

Ethernet / IP Testing Modules



PacketExpert™

- Wire-Speed BERT
- Layer-wise and Smart Loopback
- RFC 2544 (Single and Dual Port)
- ITU-T Y.1564 (ExpertSAM™)
- Wire-Speed Record / Playback with Filter

PacketExpert™ 1G Portable Unit

- Interfaces
 - 2 x 10/100/1000 Base-T Electrical only
 - 2 x 1000 Base-X Optical OR 10/100/1000 Base-T Electrical
 - Single Mode or Multi Mode Fiber SFP support with LC connector
 - Optional 4-Port SMA Jack Trigger Board (TTL Input/Output)
- Protocols:
 - RFC 2544 compliance
 - ITU-T Y.1564 (ExpertSAM™)
- Power:
 - +12 Volts (Medical Grade), 3 Amps
- Bus Interface:
 - USB 2.0

Power: 12V (Medical Grade), 3A

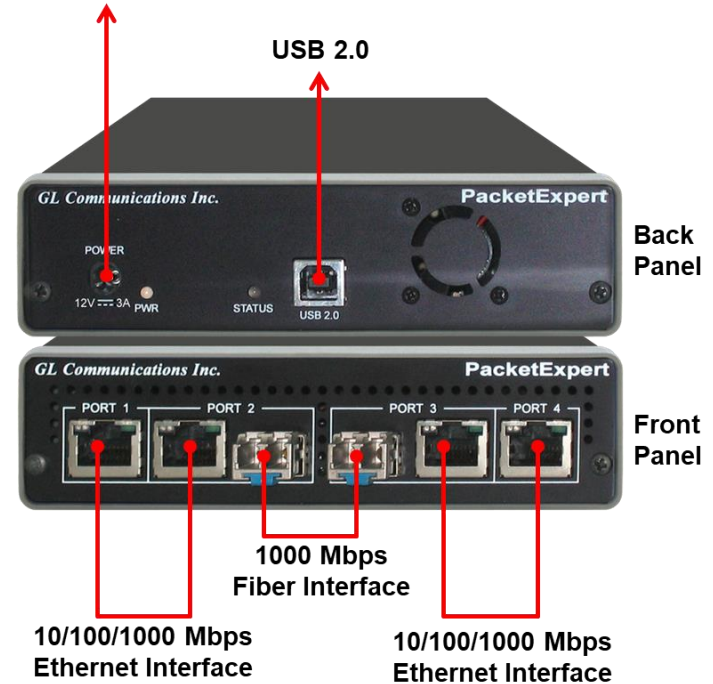

PacketExpert™ mTOP™ Probe

Front Panel View

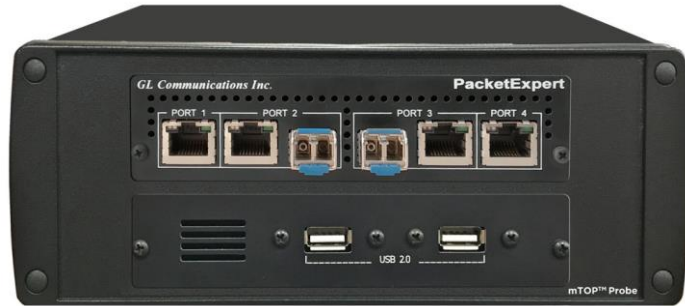

Rear Panel View



- Portable Quad Port Ethernet/VLAN/MPLS/IP/UDP Tester with 4 Electrical Ethernet Ports (10/100/1000 Mbps) and 2 Optical Ports (100/1000 Mbps). Embedded with Single Board Computer (SBC)
- **SBC Specs:** Intel Core i3 or optional i7 NUC Equivalent, Windows® 11 64-bit Pro Operating System, USB 3.0 and USB 2.0 Ports, 12V/3A Power Supply, USB Type C Ports, Ethernet 2.5GigE port, 256 GB Hard drive, 8G Memory (Min), Two HDMI ports
- Each GigE port provides independent Ethernet/VLAN/MPLS/IP/UDP testing at wire speed for applications such as BERT, RFC 2544, and Loopback. BERT is implemented for all layers
- RFC 2544 is applicable for Layers 2, 2.5, and 3, and Loopback is applicable for Layers 2, 3, and 4

PacketExpert™ High-Density 12/24 GigE Ports mTOP™ Rack

PacketExpert™ SA (PXE112) is a 12-Port PacketExpert™ w/ Embedded Single Board Computer (SBC)

SBC Specs: Intel Core i3 or optional i7 NUC Equivalent, Windows® 11 64-bit Pro Operating System, USB 3.0 and USB 2.0 Ports, ATX Power Supply, USB Type C Ports, Ethernet 2.5GigE port, 256 GB Hard drive, 8G Memory (Min), Two HDMI ports.

19" 1U Rackmount Enclosure (If options, then x 3)

PacketExpert™ SA (PXE124) is a 24-Port PacketExpert™ w/ Embedded Single Board Computer (SBC)

SBC Specs: Intel Core i3 or optional i7 NUC Equivalent, Windows® 11 64-bit Pro Operating System, USB 3.0 and USB 2.0 Ports, ATX Power Supply, USB Type C Ports, Ethernet 2.5GigE port, 256 GB Hard drive, 8G Memory (Min), Two HDMI ports.

19" stacked 1U Rackmount Enclosure (If options, then x 6)

PacketExpert™ SA (PXE112)



PacketExpert™ SA (PXE124)



HD PacketExpert™ (12 and 24 GigE Ports)



- Offers higher densities from 12/24 ports form factor solution for testing GigE switches, routers and network conditions
- The chassis comprises of both electrical and optical (fiber) interfaces

ITU-T Y.1564 (ExpertSAM™)

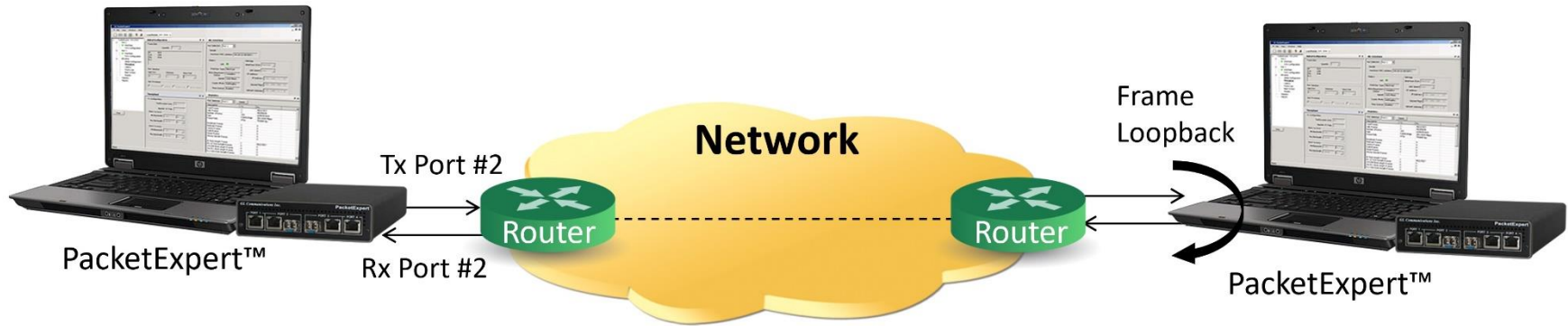

- A single test to validate service-level agreements (SLAs) as per ITU-T Y.1564 standard
- ITU-T Y.1564 completes this testing in two phases based on the SLA parameters:
 - **Service Level Agreement Parameters:** Information Rate (IR), Frame Transfer Delay (FTD), Frame Delay Variation (FDV), Frame Loss Ratio (FLR)
 - Service Configuration Test
 - Service Performance Test

Highlights

- Complete validation of Ethernet service-level agreements (SLAs) in a single test
- ITU-T Y.1564 standard compliance
- Service Configuration and Service Performance tests methodology supported
- KPIs like Information Rate (IR) or Throughput, Frame Loss Ratio (FLR), Frame Transfer Delay (FTD) or Latency, and Frame Delay Variation (FDV) or Jitter, measured simultaneously for multi streams, and Pass/Fail verdict declared
- Capability to generate traffic at throughput of CIR (guaranteed traffic), EIR (best effort bandwidth), and traffic policing (dropped bandwidth) rates ensuring Key performance indicators (KPI) validation
- EMIX frame sizes supported per service – up to 7 frame sizes can be defined per service
- Supports multiple services with varying performance requirements that meets full load conditions
- Stacked VLAN supported – C-Tag and S-Tag to simulate Carrier Ethernet traffic
- Simultaneous validation of all the services quality over time

RFC 2544 VS Y.1564 (ExpertSAM™)

	RFC 2544	Y.1564
Measurements	Throughput, burst ability, frame loss and latency	Throughput, burst ability, frame loss, latency, packet jitter, QoS
Services	Link level	Multiple concurrent service levels
Performance	Measuring maximum performance	Key performance indicators (KPI) validation
Throughput	No separation of the committed and excess traffic	CIR, EIR and Traffic Policing constantly ensuring that KPI are met during the test
Frame Delay	Tests one frame in every test time and does not consider any latency variation that might occur over a longer test period.	Latency is measured during the test on all the generated frames measuring any deviation out of the defined range
Frame loss	Frame loss is measured during rate distribution throughput test where the frame loss distribution doesn't align with committed rate without complying to the KPI	Frame loss measurement during throughput test
Frame Delay Variation	Frame delay variation is not measured	Frame delay variation is measured for traffic generated up to the CIR ensuring proper traffic prioritization

ITU-T Y.1564 (ExpertSAM™)

- **Service Configuration Test** - confirms the end-to-end configuration with the SLA parameters for all configured traffic streams
- **Service Performance Test** - transmits all configured traffic streams simultaneously CIR confirming all traffic can transverse the network under full load with the above-mentioned parameters

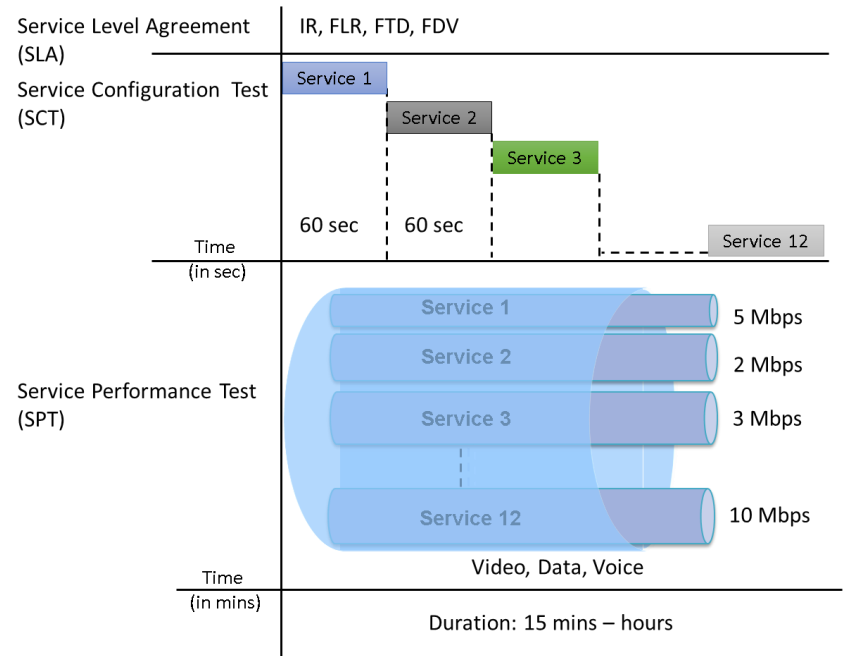

ITU-T Y.1564 (ExpertSAM™) Graph



BW Profile		
CIR	<input type="text" value="80.00"/>	Mbps
EIR	<input type="text" value="90.00"/>	Mbps
Traffic Policing Rate	<input type="text" value="100.00"/>	Mbps

- User can set the Committed Information Rate, Excess Information Rate and the Traffic Policing Rate per stream. These rates are generated during the Service Configuration test

Service Configurations

Service Configuration Expanded View

Service Configuration Collapsed Summary View

Services

Service Services 1 Copy

Frame Size - Fixed,512

Layer - Ethernet,IPv4,UDP

Ethernet - 00-21-c2-00-09-cd -> 10-11-11-11-11-11, Len/Type(08-00)

VLAN - Disabled

IPv4 - 192.168.1.101 -> 192.168.1.201 Protocol (UDP)

UDP - 10100 -> 20100

Payload - Fixed Pattern, 12-34

V Profile - CIR = 80.000 Mbps,EIR = 90.000 Mbps,Policing Rate = 100.0

Color Aware = Off

SAC Parameters - FLR = 1.000 %,FTD = 5.000 msec,FDV = 5.000 msec

Services

Service Services 1 Copy

Frame Size - Fixed,512

Layer - Ethernet,VLAN,IPv4,UDP

Ethernet

MAC

Source MAC Address 00-21-c2-00-0a-15

Destination MAC Address 10-11-11-11-11-11 Resolve

Length/Type 08-00 IPv4

VLAN

VLAN Enable

C-Tag Type 81-00 ID 0 Priority 0

S-Tag Type 88-A8 ID 0 Priority 0

IPv4 - 192.168.1.101 -> 192.168.1.201 Protocol (UDP)

UDP - 10100 -> 20100

Payload - Fixed Pattern, 12-34

BW Profile

CIR 80.00 Mbps

EIR 90.00 Mbps

Traffic Policing Rate 100.00 Mbps

Color Aware = On, Color Method = IP DSCP

Color Aware

Color Method IP DSCP

Green Frames 1,2

Yellow Frames 3,4

SAC Parameters

Frame Loss Ratio 10.00 %

Frame Transfer Delay 500.000 msec

Frame Delay Variation 500.000 msec

V-LAN C-Tag Configuration

VLAN C-Tag Frame Format

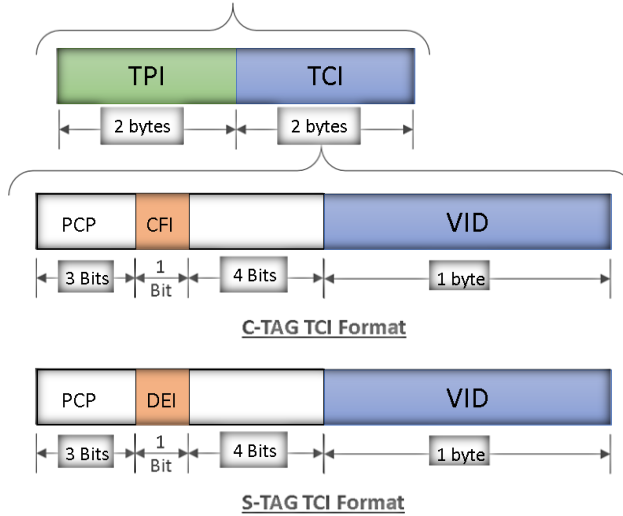
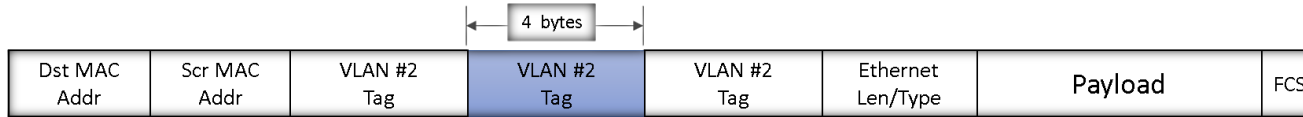

* Tag Control Information (TCI)

VLAN C-Tag Configuration

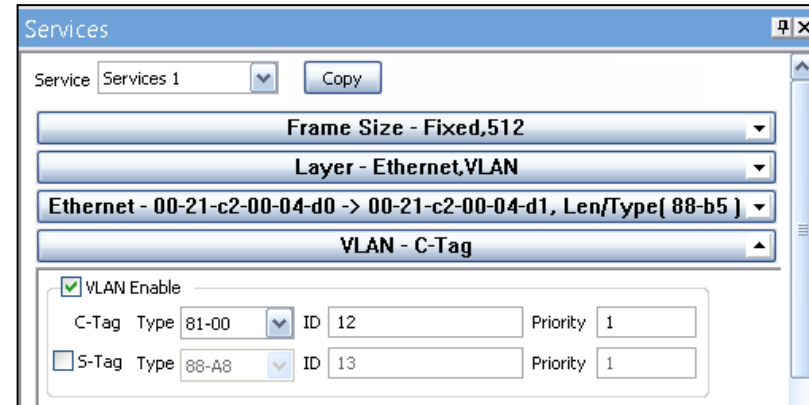

Service Configuration Test Results

Service Result Overview

Service Configuration Results Overview							
Overview 							
#	Service Name	Verdict	Current Step	Max IR(Mbps)	FLR(%)	Max FTD(msec)	Max
1	↑ Service1	✓	-	99.9266	0.0000	0.0218	0.0001
2	↑ Service2	✓	-	10.0001	0.0000	0.0089	0.0001
3	↑ Service3	✓	-	4.0009	0.0000	0.0131	0.0001
4	↑ Service4	✓	-	99.9266	0.0000	0.0216	0.0001
5	↑ Service5	✓	-	99.9266	0.0000	0.0216	0.0001
6	↑ Service6	✓	-	99.9266	0.0000	0.0217	0.0001
7	↑ Service7	✓	-	59.9482	0.0000	0.0080	0.0001
8	↑ Service8	✓	-	199.8490	0.0000	0.0216	0.0001
9	↑ Service9	✓	-	7.0011	0.0000	0.0216	0.0001
10	↑ Service10	✓	-	77.9699	0.0000	0.0215	0.0001
11	↑ Service11	✓	-	199.8490	0.0000	0.0216	0.0001
12	↑ Service12	✓	EIR	41.9642	0.0000	0.0215	0.0001

Service Detail Results

Service Configuration Results Details																
Service		Service1	IR(Mbps), FLR(%)		Vertical		FTD Unit msec		FDV Unit msec							
Test	Verdict	IR (Curr)	IR (Min)	IR (Mean)	IR (Max)	FLR (Count)	FLR (Rate)	FTD (Curr)	FTD (Min)	FTD (Mean)	FTD (Max)	FDV (Curr)	FDV (Min)	FDV (Mean)	FDV (Max)	
Step1	PASS	24.96	24.96	24.98	25.00	9	0.15	0.02134	0.02132	0.02138	0.02168	0.000123	0.000118	0.000129	0.000133	
Step2	PASS	49.95	49.92	49.96	49.97	10	0.09	0.02134	0.02131	0.02381	0.02180	0.000125	0.000122	0.000127	0.000131	
CIR	PASS	99.91	99.88	99.91	99.93	18	0.08	0.02131	0.02131	0.02138	0.02182	0.000132	0.000127	0.000130	0.000132	
EIR(Green)	PASS	99.15	99.15	99.84	99.94	0	0.00	0.02133	0.02131	0.02377	0.02197	0.000096	0.000093	0.000096	0.000098	
EIR(Yellow)	--	9.92	9.92	9.98	10.00	0	0.00	0.00000	0.00000	0.00000	0.00000	0.000133	0.000131	0.000132	0.000134	
TrafficPo...	--	99.74	99.74	99.91	99.94	0	0.00	0.02180	0.02131	0.03057	0.02180	0.000113	0.000112	0.000114	0.000116	
TrafficPo...	--	49.87	49.87	49.95	49.97	0	0.00	0.00000	0.00000	0.00000	0.00000	0.000130	0.000126	0.000129	0.000130	

Service Performance Test Overall Status

The screenshot displays a software window titled "Overall Status". At the top, it shows "Overall Status" with an upward arrow icon, "Global Verdict" set to "PASS" in a text box, and a green checkmark icon.

Test	Stream No	Subtest	Step No
Service Performance Test	-	-	-

Alarm	Status
Link Status	●
IR	●
FLR	●
FTD	●
FDV	●

Service Performance Test Results

Service Performance Results

IR(Mbps), FLR(%), FTD(msec), FDV(msec) Test Time 00:01:09 Vertical ||||| FTD Unit msec FDV Unit usec

Service	Verdict	IR (Curr)	IR (Min)	IR (Avg)	IR (Max)	FL (Count)	FLR (Rate)	FTD (Curr)	FTD (Min)	FTD (Avg)	FTD (Max)	FDV (Curr)	FDV (Min)	FDV (Avg)	FDV (Max)
1	PASS	79.90	79.90	79.94	79.95	0	0.000	0.002	0.002	0.002	0.002	0.003000	0.003000	0.003000	0.016000
2	PASS	79.90	79.90	79.94	79.95	0	0.000	0.002	0.002	0.002	0.002	0.003000	0.003000	0.003000	0.016000
3	PASS	79.91	79.90	79.94	79.95	0	0.000	0.002	0.002	0.002	0.002	0.003000	0.003000	0.003000	0.016000
4	PASS	79.91	79.90	79.94	79.95	0	0.000	0.002	0.002	0.002	0.002	0.003000	0.003000	0.003000	0.016000
5	PASS	79.91	79.90	79.94	79.95	0	0.000	0.002	0.002	0.002	0.002	0.003000	0.003000	0.003000	0.016000
6	PASS	79.91	79.90	79.94	79.95	0	0.000	0.002	0.002	0.002	0.002	0.003000	0.003000	0.003000	0.016000
7	PASS	79.91	79.90	79.94	79.95	0	0.000	0.002	0.002	0.002	0.002	0.003000	0.003000	0.003000	0.016000
8	PASS	79.90	79.89	79.94	79.95	0	0.000	0.002	0.002	0.002	0.002	0.003000	0.003000	0.003000	0.016000
9	PASS	79.90	79.89	79.94	79.95	0	0.000	0.002	0.002	0.002	0.002	0.003000	0.003000	0.003000	0.016000
10	PASS	79.90	79.89	79.94	79.95	0	0.000	0.002	0.002	0.002	0.002	0.003000	0.003000	0.003000	0.016000
11	PASS	79.90	79.89	79.94	79.95	0	0.000	0.002	0.002	0.002	0.002	0.003000	0.003000	0.003000	0.016000
12	PASS	79.90	79.89	79.94	79.95	0	0.000	0.002	0.002	0.002	0.002	0.003000	0.003000	0.003000	0.016000

Report Generation

Report Generation

Reports 🔍 ✕

Choose Format ▼

Title

User Comments

Header

Footer

User Logo ⋮

File name ⋮

Sample PDF Report

Testpdf.pdf - Adobe Reader

File Edit View Window Help

1 / 2 66.7%

Comment Share

EP100214

Packet Expert Report

Hardware Ethernet Test Tool

ExpertSAM

Test Date : 10/3/14
Start Time : 11:32:51
End Time : 11:34:57

Test Report :

User Comments :

Interface

Port Selection : 2
Interface IP Address : 102.161.122
Interface Type : Electrical
Auto-Negotiation Status : Consistent
Speed : 0
Duplex Mode : Full Duplex
Flow Control : Enabled

Test Selection

CIR Configuration Test Type : DisplayCIR
EIR Configuration Test : Enabled
Traffic Following Test : Enabled
Service Configuration Step Duration : 10
Service Performance Test : Enabled
Service Performance Test Duration : 1

Service Selection

Services : Service1
Service Count : 1

Service1 Configuration Results

Test	Verdict	FW(M)	FW(M)	FW(M)	FLC(M)	FLR(M)	FTD(M)	FTD(M)	FTD(M)	FDV(M)	FDV(M)	FDV(M)
CIR	PASS	99.97106	99.96126	99.96162	0	0	0.00002	0.00013	0.00040	0.00002	0.00002	0.00002
EP1(Over)	PASS	99.91000	99.94794	100.00000	0	0	0.00002	0.00013	0.00040	0.00002	0.00002	0.00002
EP1(Flow)	PASS	24.00040	24.00749	25.11040	0.00000	0	0.00002	0.00013	0.00040	0.00002	0.00002	0.00002
TestPerformance	-	34.01040	34.04794	100.00000	0	0	0.00002	0.00013	0.00040	0.00002	0.00002	0.00002
MT	-	24.00040	24.00749	25.11040	0.00000	0	0.00002	0.00013	0.00040	0.00002	0.00002	0.00002

Service Performance Results

Test	Verdict	FW(M)	FW(M)	FW(M)	FLC(M)	FLR(M)	FTD(M)	FTD(M)	FTD(M)	FDV(M)	FDV(M)	FDV(M)
1	-	99.94976	100.00000	100.00000	0	0	0.00002	0.00013	0.00040	0.00002	0.00002	0.00002

Over All Status

Global Verdict : PASS

16.54 x 23.39 in

Thank you